

VEO-SWC44 & VEO-SWC44TH / VEO-SWC44TU

SWITCHERS & MATRIXES

Wireless Conferencing and Presentation Switcher



USER MANUAL



Web UI	WebGUI Setting	Network Settings	Display & Audio	Moderator Control	System Settings	Security Settings	Firmware Upgrade	Other Settings	UCC Device Manager
HW	Management & Configuration	DESCRIPTION & FEATURES	INSTALL & CONNECT	START-UP & OPERATION	FIRMWARE UPDATE	PANEL FUNCTIONS & WIRELESS TRANSMITTERS	TROUBLESHOOTING	TECHNICAL DATA	
	PRECAUTIONS	PACKAGE CONTENTS							

TABLE OF CONTENTS

1. PRECAUTIONS.....	5
1.1 <i>Important Remark</i>	5
1.2 <i>Important Safety Instructions</i>	6
1.3 <i>Cleaning</i>	6
2. PACKAGE CONTENTS	7
3. DESCRIPTION and FEATURES	7
3.1 <i>Main Features</i>	7
3.2 <i>Optional Accessories</i>	8
4. INSTALL & CONNECT	9
4.1 <i>Wall Mount Install</i>	9
4.2 <i>Connection Diagram</i>	10
4.3 <i>Power Connection</i>	10
4.4 <i>Video Connection</i>	11
4.5 <i>Audio Connection</i>	11
4.6 <i>LAN Connection</i>	12
4.7 <i>USB Control Devices Connection</i>	13
4.8 <i>USB Conferencing Devices Connection</i>	14
5. START-UP and OPERATION.....	15
5.1 <i>Home Screen</i>	15
5.2 <i>Pairing VEO-SWC44TH and VEO-SWC44TU with VEO-SWC44</i>	17
5.3 <i>Wireless Presentation Mode</i>	18
5.3.1 <i>Screen Sharing using VEO-SWC44TH and VEO-SWC44TU</i>	18
5.3.2 <i>Screen Sharing using VEOShare Desktop Application</i>	19
5.3.3 <i>Screen Sharing using Airplay</i>	23
5.3.4 <i>Screen Sharing using Miracast</i>	24
5.3.5 <i>Screen Sharing using Chromecast</i>	26
5.4 <i>Wireless Conferencing Mode</i>	28
5.5 <i>Moderator Preview Window</i>	29
5.6 <i>Whiteboard & Annotation</i>	30
5.6.1 <i>Whiteboard</i>	30
5.6.2 <i>Annotation</i>	32
6. WebGUI SETTING MANAGEMENT & CONFIGURATION	34
6.1 <i>Network Settings</i>	35

Home	
HW	Web UI
PRECAUTIONS	WebGUI Setting Management & Configuration
PACKAGE CONTENTS	Network Settings
DESCRIPTION & FEATURES	Display & Audio
INSTALL & CONNECT	Moderator Control
START-UP & OPERATION	System Settings
FIRMWARE UPDATE	Security Settings
PANEL FUNCTIONS & WIRELESS TRANSMITTERS	Firmware Upgrade
TROUBLESHOOTING	Other Settings
TECHNICAL DATA	UCC Device Manager

6.1.1	Wireless Network	35
6.1.2	Ethernet.....	43
6.1.3	Auto Change Password	43
6.2	Display & Audio	44
6.2.1	HDMI	44
6.2.2	Audio.....	46
6.2.3	Airplay Screen Quality.....	46
6.2.4	Start Screen	47
6.2.5	Home Screen Background Image.....	47
6.3	Moderator Control.....	48
6.3.1	Moderator Layout.....	48
6.4	System Settings.....	49
6.4.1	Buttons	49
6.4.2	Date & Time	50
6.4.3	Auto Standby.....	51
6.4.4	Language	51
6.4.5	Reset	52
6.4.6	Configuration File.....	52
6.4.7	Series Port Setting	53
6.4.8	Telnet Switch.....	55
6.4.9	Reboot	55
6.5	Security Settings.....	56
6.5.1	Security Level	56
6.5.2	Login Password	57
6.5.3	Connection Password	57
6.6	Firmware Upgrade	58
6.6.1	Firmware Update	58
6.6.2	Automatic Upgrading.....	58
6.7	Other Settings.....	58
6.7.1	Autocreate Launcher.....	58
6.7.2	Clear History After Meeting.....	59
6.8	UCC Device Manager.....	59
6.8.1	USB Camera.....	59
6.8.2	USB Audio	60
7.	FIRMWARE UPDATE.....	61
7.1	Upgrading Firmware version of VEO-SWC44	61
7.2	Upgrading Firmware version of VEO-SWC44TH / VEO-SWC44TU.....	63
8.	PANEL FUNCTIONS and WIRELESS TRANSMITTERS	64
8.1	Front Panel.....	64

Home	
HW	Web UI
PRECAUTIONS	WebGUI Setting Management & Configuration
PACKAGE CONTENTS	Network Settings
DESCRIPTION & FEATURES	Display & Audio
INSTALL & CONNECT	Moderator Control
START-UP & OPERATION	System Settings
FIRMWARE UPDATE	Security Settings
PANEL FUNCTIONS & WIRELESS TRANSMITTERS	Firmware Upgrade
TROUBLESHOOTING	Other Settings
TECHNICAL DATA	UCC Device Manager

8.2	Rear Panel	65
8.2.1	Factory Reset Using Rear Panel Button	66
8.3	Wireless Transmitters	68
8.3.1	VEO-SWC44TH	68
8.3.2	VEO-SWC44TU	68
8.3.3	LED Indicator	69
9.	TROUBLESHOOTING	70
10.	TECHNICAL DATA	75
10.1	Technical Specifications	75
10.2	Mechanical Diagram	77

Home	
HW	Web UI Management & Configuration
PRECAUTIONS	WebUI Setting
PACKAGE CONTENTS	Network Settings
DESCRIPTION & FEATURES	Display & Audio
INSTALL & CONNECT	Moderator Control
START-UP & OPERATION	System Settings
FIRMWARE UPDATE	Security Settings
PANEL FUNCTIONS & WIRELESS TRANSMITTERS	Firmware Upgrade
TROUBLESHOOTING	Other Settings
TECHNICAL DATA	UCC Device Manager

1. PRECAUTIONS

1.1 Important Remark



WARNING: SHOCK HAZARD - DO NOT OPEN

AVIS: RISQUE DE CHOC ÉLECTRIQUE - NE PAS OUVRIR



The lightning flash with arrowhead symbol, within an equilateral triangle, is intended to alert the user to the presence of uninsulated “dangerous voltage” within the product’s enclosure that may be of sufficient magnitude to constitute a risk of electric shock to persons.



The exclamation point within an equilateral triangle is intended to alert the user to the presence of important operating and maintenance (servicing) instructions in the literature accompanying the appliance.

WARNING (If applicable): The terminals marked with symbol of “⚡” may be of sufficient magnitude to constitute a risk of electric shock. The external wiring connected to the terminals requires installation by an instructed person or the use of ready-made leads or cords.

WARNING: To prevent fire or shock hazard, do not expose this equipment to rain or moisture.

WARNING: A device with Class I construction shall be connected to a mains socket-outlet with a protective earthing connection.



WARNING: This product must not be discarded, under any circumstance, as unsorted urban waste. Take to the nearest electrical and electronic waste treatment centre.



This equipment has been tested and found to comply with the limits for a Class A digital device, pursuant to part 15 of the FCC Rules. These limits are designed to provide reasonable protection against harmful interference when the equipment is operated in a commercial environment. This equipment generates, uses, and can radiate radio frequency energy and, if not installed and used in accordance with the instruction manual, may cause harmful interference to radio communications. Operation of this equipment in a residential area is likely to cause harmful interference in which case the user will be required to correct the interference at his own expense.

Home	HW	Web 5	WebGUI Setting Management & Configuration	Network Settings	Display & Audio	Moderator Control	System Settings	Security Settings	Firmware Upgrade	Other Settings	UCC Device Manager	TECHNICAL DATA
	PRECAUTIONS											
			PACKAGE CONTENTS	DESCRIPTION & FEATURES	INSTALL & CONNECT	START-UP & OPERATION	FIRMWARE UPDATE	PANEL FUNCTIONS & WIRELESS TRANSMITTERS				

1.2 Important Safety Instructions

1. Read these instructions.
2. Keep these instructions.
3. Heed all warnings.
4. Follow all instructions.
5. Do not use this device near water.
6. Clean only with dry cloth.
7. Do not block any ventilation openings. Install in accordance with the manufacturer's instructions.
8. Do not install near any heat sources such as radiators, heat registers, stoves, or other device (including amplifiers) that produce heat.
9. Do not defeat the safety purpose of the polarized or grounding type plug. A polarized plug has two blades with one wider than the other. A grounding type plug has two blades and a third grounding prong. The wide blade or the third prong are provided for your safety. If the provided plug does not fit into your outlet, consult an electrician for replacement of the obsolete outlet.
10. Protect the power cord from being walked on or pinched particularly at the plugs, convenience receptacles, and at the point where they exit from the device.
11. Only use attachments/accessories specified by the manufacturer.
12. Unplug the device during lightning sorts or when unused for long periods of time.
13. Refer all servicing to qualified personnel. Servicing is required when the device has been damaged in any way, such as power supply cord or plug is damaged, liquid has been spilled or objects have fallen into the device, the device has been exposed to rain or moisture, does not operate normally, or has been dropped.
14. Disconnecting from mains: When switching off the POWER switch, all the functions and light indicators of the unit will be stopped, but fully disconnecting the device from mains is done by unplugging the power cable from the mains input socket. For this reason, it always shall remain easily accessible.
15. Equipment is connected to a socket-outlet with earthing connection by means of a power cord.
16. The marking information is located at the bottom of the unit.
17. The device shall not be exposed to dripping or splashing and that no objects filled with liquids, such as vases, shall be placed on device.

1.3 Cleaning



Clean the unit with a soft, dry clean cloth or slightly wet with water and neutral liquid soap only, then dry it with a clean cloth. Be careful that water never gets into the unit through any hole. Never use alcohol, benzine, solvents or abrasive substances to clean this unit.

NEEC AUDIO BARCELONA, S.L. accepts no liability for any damage that may be caused to people, animal, or objects due to failure to comply with the warnings above.

Home	Web UI	Web UI Setting Management & Configuration	Network Settings	Display & Audio	Moderator Control	System Settings	Security Settings	Firmware Upgrade	Other Settings	UCC Device Manager	TECHNICAL DATA
HW	HW	PRECAUTIONS	PACKAGE CONTENTS	DESCRIPTION & FEATURES	INSTALL & CONNECT	START-UP & OPERATION	FIRMWARE UPDATE	PANEL FUNCTIONS & WIRELESS TRANSMITTERS	TROUBLESHOOTING		

**Thank you for choosing our device Ecler
VEO-SWC44 / VEO-SWC44TH / VEO-SWC44TU !
We appreciate your trust.**

It is **VERY IMPORTANT** to carefully read this manual and to fully understand its contents before any connection in order to maximize your use and get the best performance from this equipment.

To ensure optimal operation of this device, we strongly recommend that its maintenance be carried out by our authorised Technical Services.

Ecler VEO-SWC44 / VEO-SWC44TH / VEO-SWC44TU comes with a 5-year warranty.

2. PACKAGE CONTENTS

- VEO-SWC44.
- Antenna (3 units). Not pre-mounted to avoid damages.
- First Steps Guide.
- Warranty card.

3. DESCRIPTION and FEATURES

VEO-SWC44 is a wireless conferencing and presentation switcher with Full HD video resolution wireless inputs and a 4K / UHD HDMI 2.0 video output. It supports wireless connection for USB devices like webcam and mic via wireless transmitter, Windows & macOS applications, as well as Airplay, Miracast and Chromecast compliant. An integrated audio de-embedder provides stereo unbalanced analogue output on a 3,5mm jack connector. It includes a WebGUI for configuration and management as well as RS-232, TCP/IP remote control, all enabled by a pair of LAN RJ-45 connectors with independent networks available. It can display to 4 simultaneous devices in a multi-view layout. Adds smart EDID management and supports HDCP 2.2 as well as PoE powering supply.

3.1 Main Features

- USB 3.0 ports for wireless connection between a laptop and room USB devices like camera and mic for an easy video conference.
- Wireless input up to Full HD video resolution and a HDMI 2.0 4K / UHD video output.
- Analogue audio extraction on stereo unbalanced 3,5mm jack connector.

HW	Web 5	WebGUI Setting Management & Configuration	Network Settings	Display & Audio	Moderator Control	System Settings	Security Settings	Firmware Upgrade	Other Settings	UCC Device Manager	TECHNICAL DATA
		PRECAUTIONS	DESCRIPTION & FEATURES	INSTALL & CONNECT	START-UP & OPERATION	FIRMWARE UPDATE	PANEL FUNCTIONS & WIRELESS TRANSMITTERS	TROUBLESHOOTING			

- Support for native wireless mirroring protocols like Airplay Chromecast and Miracast for a flawless presentation.
- Plug-n-play by optional wireless transmitters HDMI VEO-SWC44TH or USB Type-C VEO-SWC44TU as well as Windows and macOS apps for wireless connection with a laptop or PC.
- RS-232 and IP control as well as WebGUI management.
- Extra security layer for an encrypted wireless transmission.
- Support for up to 4 simultaneous split screen view presentation as well as up to 16 participants on hold.
- Customizable background image or logo for the Home Screen page.
- Support wireless touchback for interactive screen as well as whiteboard and live annotation tool.
- Support for PoE.
- Local 12V DC power supply.

3.2 Optional Accessories

Wireless transmitters: VEO-SWC44TH and VEO-SWC44TU, used for plug & play wireless mirroring from personal PC or mac desktop to the main screen.

- **VEO-SWC44TH** is a HDMI wireless transmitter that allows participants to easily share content from a laptop or HDMI device to the VEO-SWC44 base unit. Power is supplied by an auxiliary USB Type A connector. It is designed as a cross platform and plug and play device with no additional driver installation needed. This technology allows to start a transmission and begin sharing content by just connecting the wireless transmitter into the source and pushing the surface. A LED indicator and a vibration driver, both allow the user to know the status of the wireless transmitter at any time.
- **VEO-SWC44TU** is an USB-C wireless transmitter that allows participants to easily share content from a laptop or USB-C video device to the VEO-SWC44 base unit. Power is supplied directly through the same connector. It is designed as a cross platform and plug and play device with no additional driver installation needed. This technology allows to start a transmission and begin sharing content by just connecting the wireless transmitter into the source and pushing the surface. A LED indicator and a vibration driver, both allow the user to know the status of the wireless transmitter at any time.

Home	
HW	Web GUI
PRECAUTIONS	WebGUI Setting Management & Configuration
PACKAGE CONTENTS	Network Settings
DESCRIPTION & FEATURES	Display & Audio
INSTALL & CONNECT	Moderator Control
START-UP & OPERATION	System Settings
FIRMWARE UPDATE	Security Settings
PANEL FUNCTIONS & WIRELESS TRANSMITTERS	Firmware Upgrade
TROUBLESHOOTING	Other Settings
TECHNICAL DATA	UCC Device Manager

4. INSTALL & CONNECT

4.1 Wall Mount Install

The VEO-SWC44 can be installed on the wall or flat surface. At the bottom of VEO-SWC44, there are two mounting holes that can be fixed to a surface using flat screws.

! Mounting screws are not included in the VEO-SWC44 box. The **type of screws depends on the type of wall** (stone, wood, plasterboard, ...) you are mounting the Base Unit VEO-SWC44 to. **Make sure the head of the screw is not larger than the hole in the bottom of base unit VEO-SWC44.**

! For optimal performance, install the VEO-SWC44 close to the display and avoid obstacles between the VEO-SWC44 and the Transmitters.

! Antenna Placement

- The antennas should be **oriented vertically**, so perpendicular to the ceiling and parallel to the walls.
- The antennas **should be installed far enough (at least 50cm/1.6ft) from metallic surfaces** to avoid unwanted reflections and **far enough (at least 1m/3.3ft) from other radio equipment that operates in the same frequency range**, e.g. other WiFi access points, cordless telephone, microwave ovens, etc. It is also best to install antennas at least 15 cm (6 inches) from concrete walls.
- The **most favourable situation is a direct line of sight between antennas and buttons**. Any obstruction will cause the signal to follow a longer propagation path, which can result in performance degradation.
- Due to the particular radio pattern of the dipole antennas, the **antennas should not be placed just above potential positions of VEO-SWC44 users**. As a result, the advised position for the antennas is at the side of the meeting room.

HW	Web UI	Management & Configuration	Network Settings	Display & Audio	Moderator Control	System Settings	Security Settings	Firmware Upgrade	Other Settings	UCC Device Manager	TECHNICAL DATA
PRECAUTIONS	PACKAGE CONTENTS	DESCRIPTION & FEATURES	INSTALL & CONNECT	START-UP & OPERATION	FIRMWARE UPDATE	PANEL FUNCTIONS & WIRELESS TRANSMITTERS	TROUBLESHOOTING				

4.2 Connection Diagram

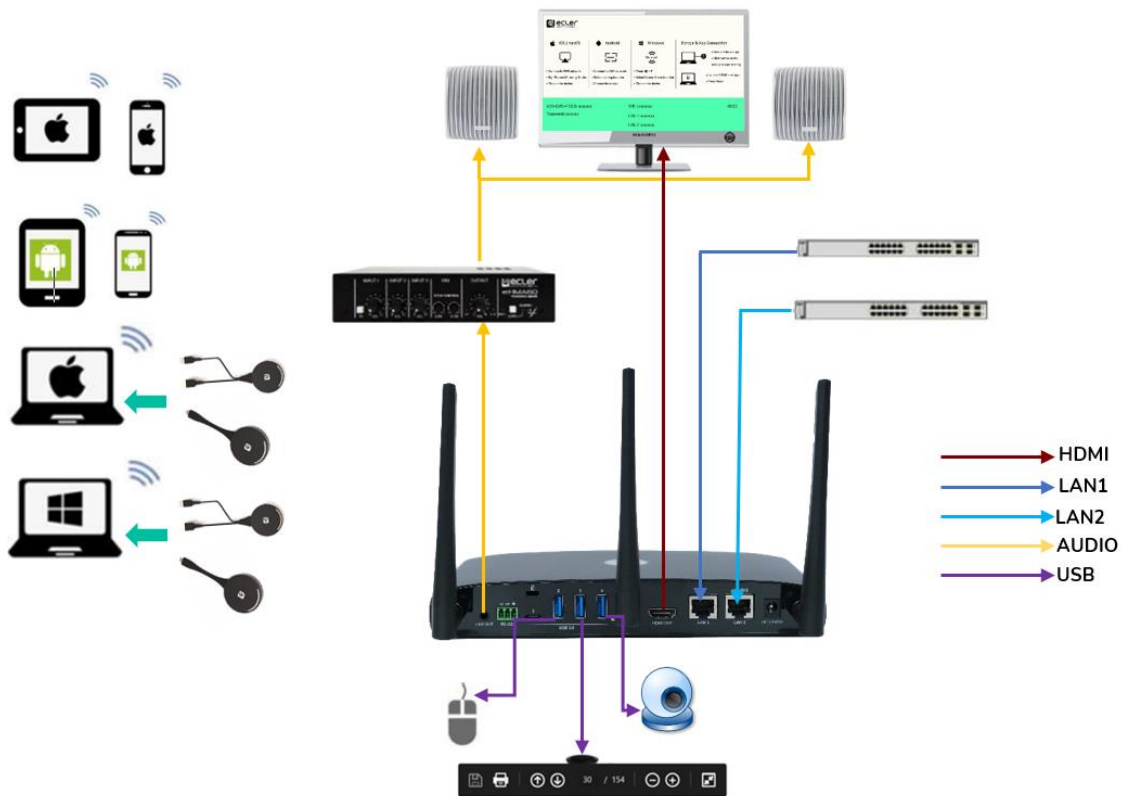

4.3 Power Connection

- **Local Power Source**

1. Plug the power connector to the power adapter to the power input connector of the Base Unit VEO-SWC44.
2. Choose the appropriate power plug (US, UK, EU or AU) to be installed on the power adapter.

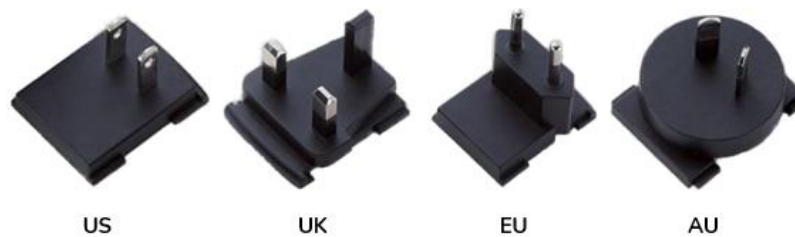

3. Connect the power cable plug into the wall outlet.

Once the VEO-SWC44 is powered it is recommended to **use the POWER button** on the front of the VEO-SWC44 to **switch ON or OFF**.

- **Power over Ethernet**

If the LAN Ethernet switcher supports PoE (Power over Ethernet), LAN 2 port can be used to power up the Base-unit VEO-SWC44 instead of using the external power adapter. (LAN2 Port of the unit supports PoE.).

Home	Web UI	Web UI Setting	Network Settings	Display & Audio	Moderator Control	System Settings	Security Settings	Firmware Upgrade	Other Settings	UCC Device Manager	TECHNICAL DATA
HW	Management & Configuration	DESCRIPTION & FEATURES	INSTALL & CONNECT	START-UP & OPERATION	FIRMWARE UPDATE	PANEL FUNCTIONS & WIRELESS TRANSMITTERS	TROUBLESHOOTING				
PRECAUTIONS	PACKAGE CONTENTS										

4.4 Video Connection

1. Connect the HDMI Output of VEO-SWC44 to a 4K or Full-HD display by a HDMI cable.
2. After starting up, the system displays the home page, as shown below.

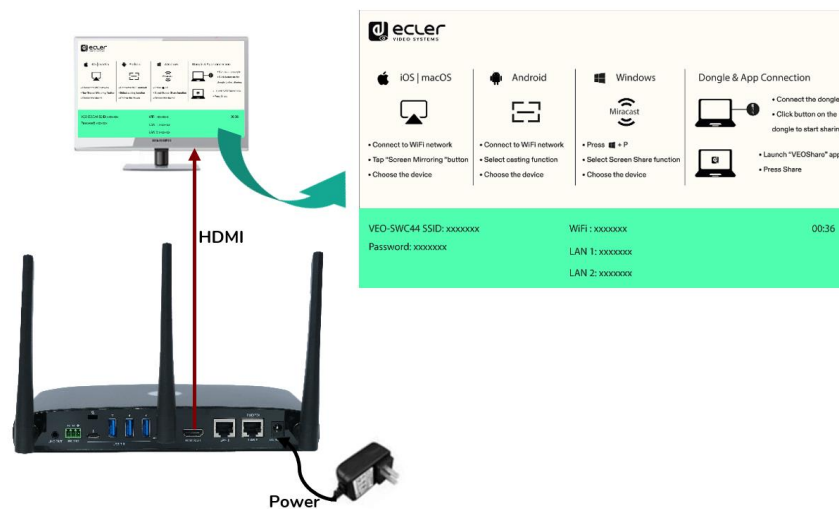

4.5 Audio Connection

1. Connect an audio cable with mini jack socket 3.5mm connector into the audio of the VEO-SWC44.
2. Connect the other side to the meeting room's sound system.

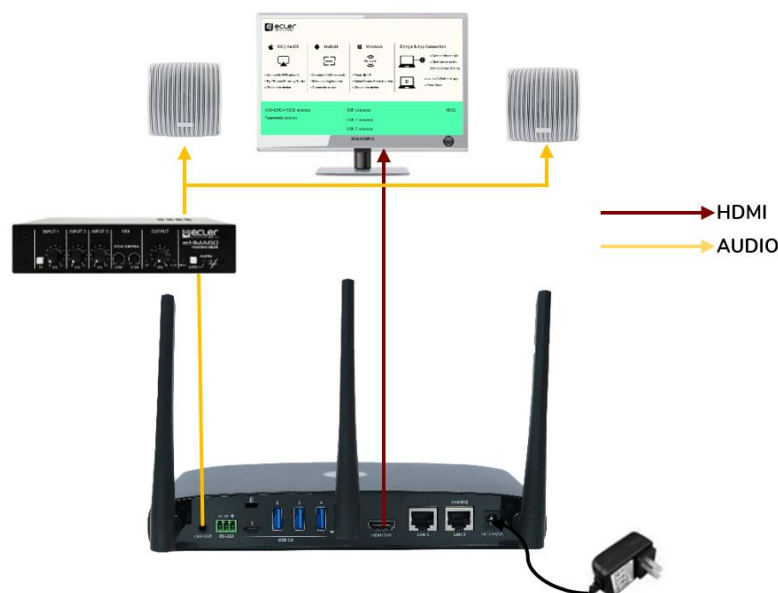

VEO-SWC44TH and VEO-SWC44TU can transmit audio to the VEO-SWC44 base unit when the audio output of the source device is selected.

Home	Web UI
HW	Web UI
PRECAUTIONS	WebUI Setting Management & Configuration
PACKAGE CONTENTS	Network Settings
DESCRIPTION & FEATURES	Display & Audio
INSTALL & CONNECT	Moderator Control
START-UP & OPERATION	System Settings
FIRMWARE UPDATE	Security Settings
PANEL FUNCTIONS & WIRELESS TRANSMITTERS	Firmware Upgrade
OTHER SETTINGS	Other Settings
TROUBLESHOOTING	UCC Device Manager
TECHNICAL DATA	

4.6 LAN Connection

1. **Connect a network cable with RJ-45 connector into the LAN 1 or LAN 2 port of Base Unit VEO-SWC44.**
2. **Connect the other side to LAN.** DHCP on the VEO-SWC44 switcher is enabled per default.
 - a) If there's a DHCP server in the network, IP address will be assigned automatically.
 - b) If there is no DHCP server in the network, VEO-SWC44 will require to manually configure a static IP address. [For further information, see chapter Network Settings.](#)

If the LAN Ethernet switcher supports PoE (Power over Ethernet), LAN 2 port of the VEO-SWC44 allows to power the switcher instead of using the external power adapter included.

Wireless Direct Mode is enabled by default. In this network mode, VEO-SWC44 generates its own wireless SSID with IP address 192.168.43.1. For further information on how to properly configure the network settings according to the needs of the application. [see chapter Wireless Network.](#)

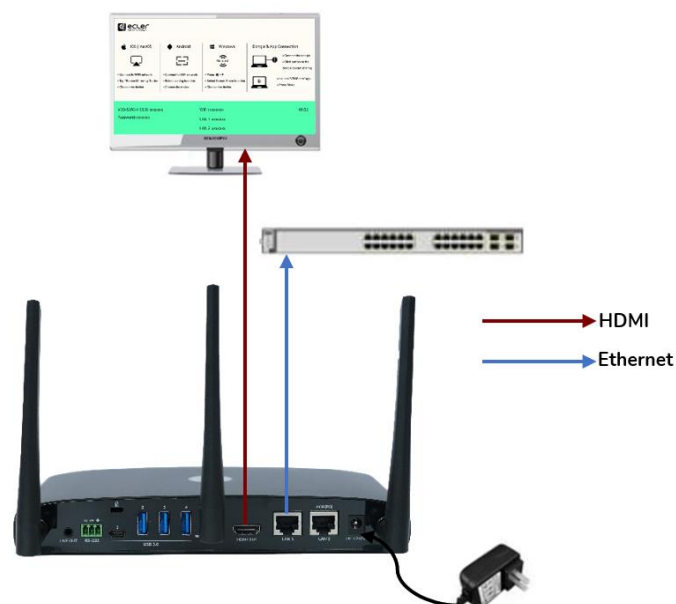

- The LAN connection can be used for:**
- Network integration of VEO-SWC44 in guest or company network.
 - Telnet control the VEO-SWC44.
 - Maintenance purpose.
 - Over-The-Air -Update (OTA) of firmware of VEO-SWC44.

Home	Web UI	Web UI Setting Management & Configuration	Network Settings	Display & Audio	Moderator Control	System Settings	Security Settings	Firmware Upgrade	Other Settings	UCC Device Manager	TECHNICAL DATA
HW	PRECAUTIONS	PACKAGE CONTENTS	DESCRIPTION & FEATURES	INSTALL & CONNECT	START-UP & OPERATION	FIRMWARE UPDATE	PANEL FUNCTIONS & WIRELESS TRANSMITTERS	TROUBLESHOOTING			

4.7 USB Control Devices Connection

If the user connects an **USB Mouse** or **Touchscreen**, the following features will be available:

- **Moderator tab** to manage the active users sharing content with the VEO-SWC44.
- **White board or annotation** during a presentation.
- **USB-HID function** for laptop control and click function of a touchscreen:
 - **USB mouse:**
 - Single click to select.
 - Right-click to back to the Home Page.
 - **Touch screen:**
 - Click to select.
 - Long press to open the contextual menus, as double-click or click the right button of a USB mouse.

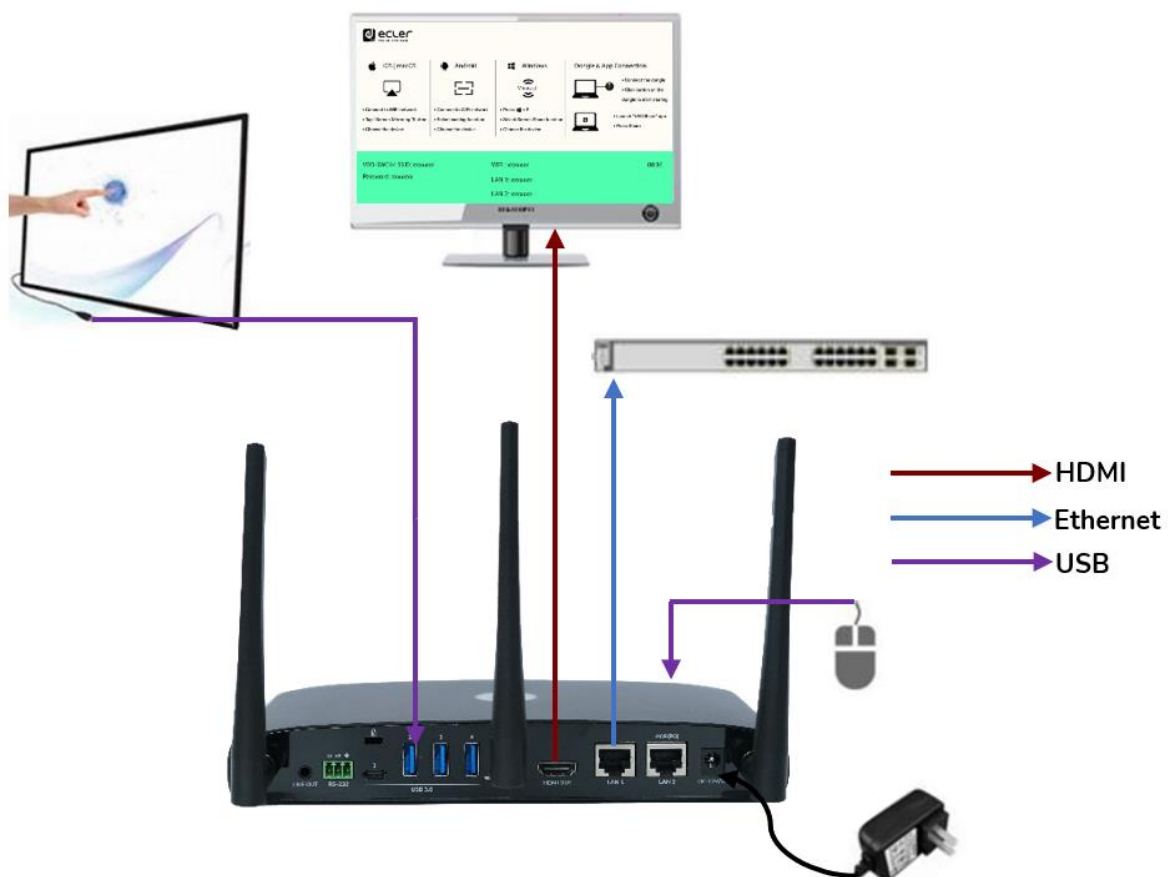

Home	Web 5	WebGUI Setting	Network Settings	Display & Audio	Moderator Control	System Settings	Security Settings	Firmware Upgrade	Other Settings	UCC Device Manager	TECHNICAL DATA
HW	Management & Configuration	PRECAUTIONS	PACKAGE CONTENTS	DESCRIPTION & FEATURES	INSTALL & CONNECT	START-UP & OPERATION	FIRMWARE UPDATE	PANEL FUNCTIONS & WIRELESS TRANSMITTERS	TROUBLESHOOTING		

4.8 USB Conferencing Devices Connection

VEO-SWC44 supports **USB Camera** and **USB speakerphone** over WiFi sharing to start meetings with conferencing software's such as Skype, Zoom, Microsoft Teams, etc. [See chapter Wireless Conferencing Mode for configuration and operation.](#)

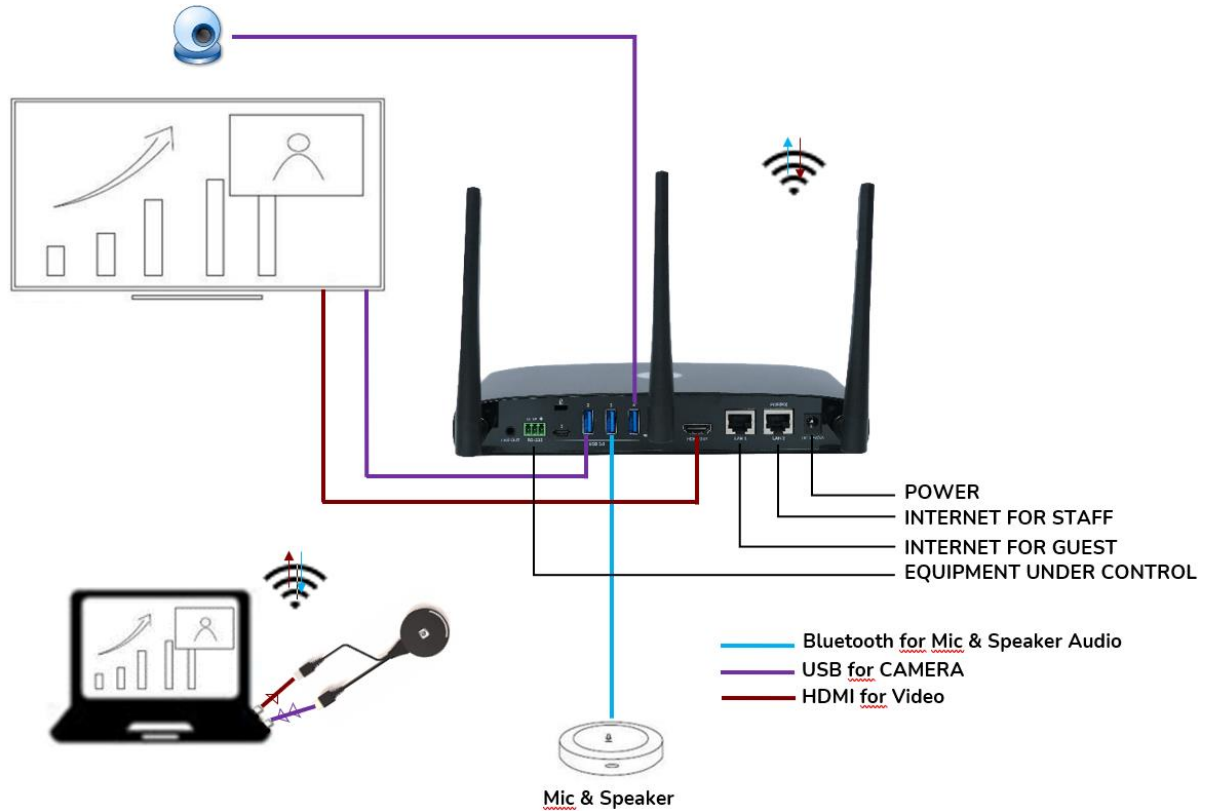

Home	Web UI
HW	Web UI
PRECAUTIONS	Management & Configuration
PACKAGE CONTENTS	Setting
DESCRIPTION & FEATURES	Network Settings
INSTALL & CONNECT	Display & Audio
START-UP & OPERATION	Moderator Control
FIRMWARE UPDATE	System Settings
PANEL FUNCTIONS & WIRELESS TRANSMITTERS	Security Settings
TROUBLESHOOTING	Firmware Upgrade
TECHNICAL DATA	Other Settings
	UCC Device Manager

5. START-UP and OPERATION

5.1 Home Screen

When a user connects the VEO-SWC44 base unit to a HDMI display, the following Home Screen is displayed:

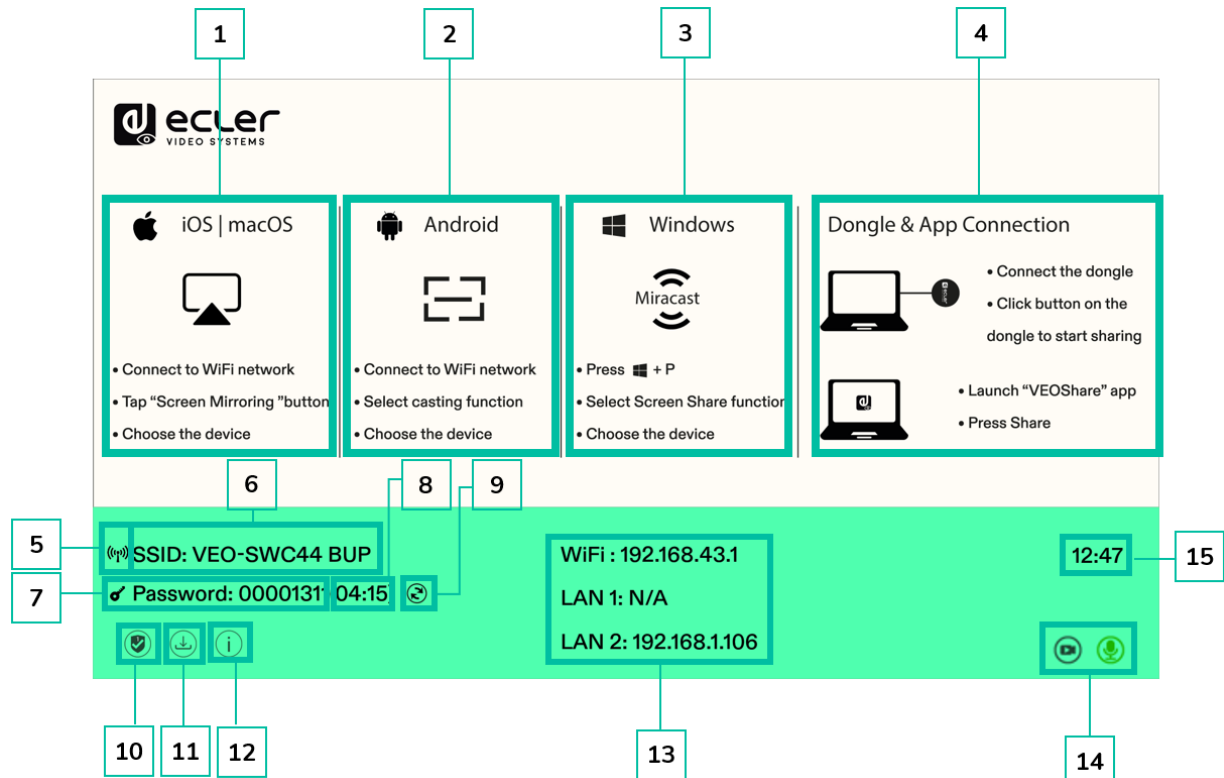

1. **iOS Quick Start:** Steps to start sharing content wirelessly using Airplay on iOS and macOS.
2. **Android Quick Start:** Steps to start sharing content wirelessly using an Android device.
3. **Windows Quick Start:** Steps to start sharing content wirelessly using a laptop that supports Miracast transmission.
4. **Wireless Transmitters & VEOShare:** Steps to start sharing content wirelessly using VEO-SWC44TH / VEO-SWC44TU wireless transmitters or VEOShare app.
5. **WiFi Indicator:** Indicates the signal quality of the current wireless network connection.
6. **ID:** Indicates the WiFi SSID name or the assigned VEO-SWC44 device name.
7. **Password:** Shows the WiFi password needed to gain access to VEO-SWC44.

Home	Web UI	Web UI Setting	Network	Display & Audio	Moderator Control	System Settings	Security Settings	Firmware Upgrade	Other Settings	UCC Device Manager	TECHNICAL DATA
HW	Management & Configuration	PRECAUTIONS	DESCRIPTION & FEATURES	INSTALL & CONNECT	START-UP & OPERATION	FIRMWARE UPDATE	PANEL FUNCTIONS & WIRELESS TRANSMITTERS	TROUBLESHOOTING			

8. **Password timer:** It shows the time until the password is changed automatically. It is only displayed when timer is active.
9. **Refresh WiFi password:** Generates a new password network.
10. **Security level:** Clicking on the icon a pop-up window will appear, displaying the security profile currently selected amongst the three levels available.
11. **Download Button:** Clicking on this icon will create a USB launcher drive containing VEOShare app.
12. **Info:** Clicking on this icon will show / hide Network information of the Home screen.
13. **WiFi / IP LAN IP:** WiFi IP: address of VEO-SWC44 in wireless LAN / Assigned IP: address of VEO-SWC44 in LAN. "N/A" means the VEO-SWC44 base unit is not connected to any WiFi / LAN networks, or it failed to get an available IP address by the assigned DHCP server. In this case, [see chapter Network settings](#).
14. **Camera and microphone icon indicator:** It is only displayed accordingly a USB camera or microphone is connected to the VEO-SWC44 base unit. When lighted in green, USB device is being used. Otherwise, is only connected.
15. **Time:** Displays current time. If VEO-SWC44 base unit has access to a time server through wireless or LAN connection, time code will be set automatically.

Home	
HW	Web UI
PRECAUTIONS	WebGUI Setting Management & Configuration
PACKAGE CONTENTS	Network Settings
DESCRIPTION & FEATURES	Display & Audio
INSTALL & CONNECT	Moderator Control
START-UP & OPERATION	System Settings
FIRMWARE UPDATE	Security Settings
PANEL FUNCTIONS & WIRELESS TRANSMITTERS	Firmware Upgrade
TROUBLESHOOTING	Other Settings
TECHNICAL DATA	UCC Device Manager

5.2 Pairing VEO-SWC44TH and VEO-SWC44TU with VEO-SWC44

Connecting VEO-SWC44TH (HDMI wireless transmitter) to USB Type A port or VEO-SWC44TU to USB-Type C port will start pairing process automatically. They should be connected one at a time.

! A transmitter can only be paired to one base unit and will always re connect to the one that was last paired to.



Once a transmitter is plugged, a message indicating that wireless transmitter is booting will be displayed.

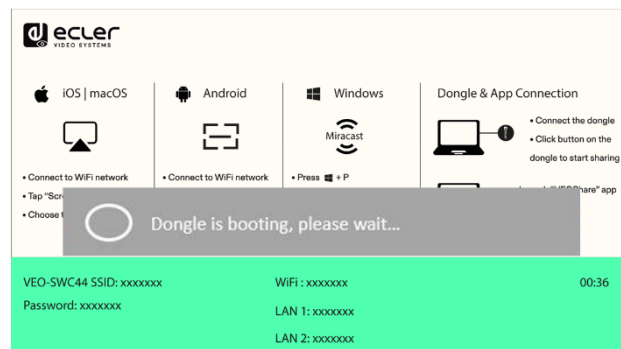

After completing the pairing, the message table displays “Succeeded to pair!” on the home page, as shown. Then, the transmitters can be unplugged and used for screen sharing content.

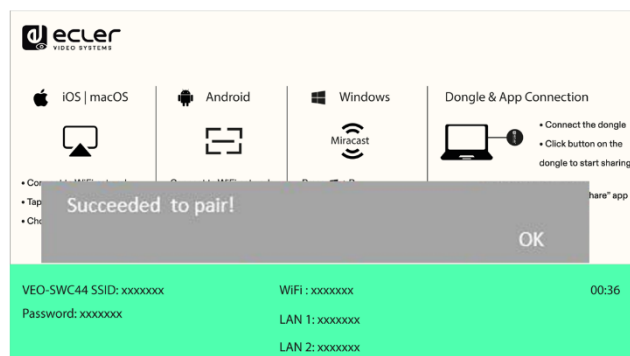

! If error-message “Configuration fail” is displayed, check the connection of USB/type C to keep stable after plug-in and try again.

! After changing the SSID / WiFi channel in Web GUI settings menu, all the transmitters must be paired again. Transmitters that need assigning to another VEO-SWC44 base unit must be paired again.

Home	Web UI	Web UI Setting	Network Settings	Display & Audio	Moderator Control	System Settings	Security Settings	Firmware Upgrade	Other Settings	UCC Device Manager	TECHNICAL DATA
HW	Management & Configuration	PRECAUTIONS	PACKAGE CONTENTS	DESCRIPTION & FEATURES	INSTALL & CONNECT	START-UP & OPERATION	FIRMWARE UPDATE	PANEL FUNCTIONS & WIRELESS TRANSMITTERS	TROUBLESHOOTING		

5.3 Wireless Presentation Mode

VEO-SWC44 can be used to wirelessly share the screen of AV sources. VEO-SWC44 can mirror 4 sources onto main display simultaneously, which supports PC/Laptop and mobile devices.

5.3.1 Screen Sharing using VEO-SWC44TH and VEO-SWC44TU

1. Pair VEO-SWC44TH or VEO-SWC44TU to VEO-SWC44 base unit, [see chapter Pairing VEO-SWC44TH and VEO-SWC44TU with VEO-SWC44.](#)
2. Plug VEO-SWC44TH to the USB-A port and HDMI port or VEO-SWC44TU to USB-C port of the device that is going to share its content.
3. LED indicator will show static green when ready. Touching the surface will start wireless presentation and LED indicator will show static red.
4. Touching the surface again will stop wireless presentation and LED indicator will go back to static green.



VEO-SWC44TH



VEO-SWC44TU

5. When LED is static red, the content is mirroring to the main screen connected to the VEO-SWC44 base unit.



VEO-SWC44TH



VEO-SWC44TU



[See chapter LED Indicator for further information on LED status.](#)

Home	Web UI	Web UI Setting Management & Configuration	Network Settings	Display & Audio	Moderator Control	System Settings	Security Settings	Firmware Upgrade	Other Settings	UCC Device Manager	TECHNICAL DATA
HW	PRECAUTIONS	PACKAGE CONTENTS	DESCRIPTION & FEATURES	INSTALL & CONNECT	START-UP & OPERATION	FIRMWARE UPDATE	PANEL FUNCTIONS & WIRELESS TRANSMITTERS	TROUBLESHOOTING			

5.3.2 Screen Sharing using VEOShare Desktop Application

VEOShare app is the launcher that lets the user screen share content with VEO-SWC44 base unit wirelessly from any source device which hosts it (mac, PC...). Just copying the launcher to the internal storage will let the user run VEOShare app.

Setting up VEOShare

There are **two ways of getting VEOShare desktop app**:

1. Downloading from WEB page

Application can be downloaded from the website by connecting the device (laptop / Android) to the same network as the VEO-SWC44 controller.

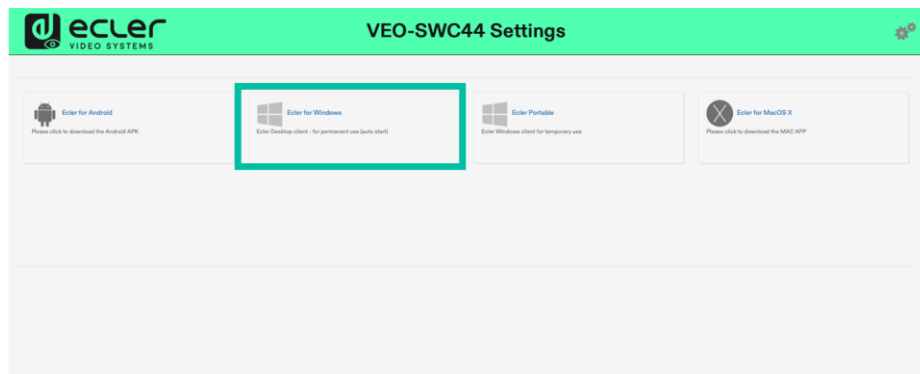

2. VEO-SWC44TH / VEO-SWC44TU internal store

Wireless transmitters will also act as a USB flash drive that hosts the VEOShare app to be drag and dropped to the laptop.

Home	Web UI	Web UI Setting	Network Settings	Display & Audio	Moderator Control	System Settings	Security Settings	Firmware Upgrade	Other Settings	UCC Device Manager	TECHNICAL DATA
HW	Management & Configuration	PRECAUTIONS	PACKAGE CONTENTS	DESCRIPTION & FEATURES	INSTALL & CONNECT	START-UP & OPERATION	FIRMWARE UPDATE	PANEL FUNCTIONS & WIRELESS TRANSMITTERS	TROUBLESHOOTING		

- macOS

1. Plug VEO-SWC44TH / VEO-SWC44TU into USB-A / USB-C port.
2. Go to the Finder and select the external USB flash unit.

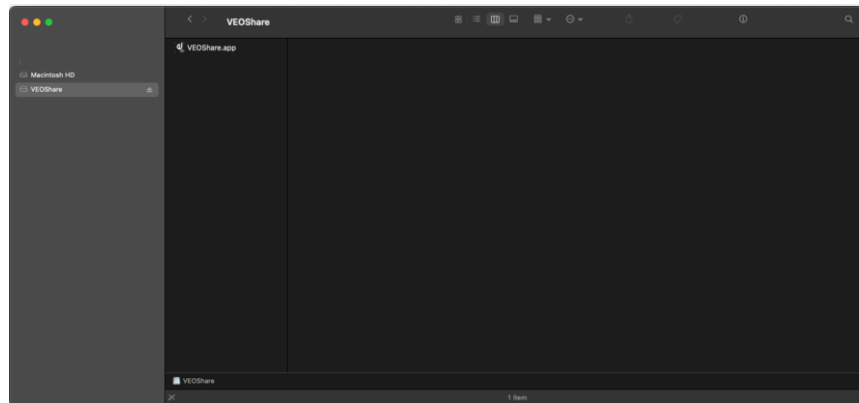

3. Copy VEOShare app to local storage

- Windows

1. Plug VEO-SWC44TH / VEO-SWC44TU into USB-A / USB-C port.
Go to the File Explorer and select the external USB flash unit.

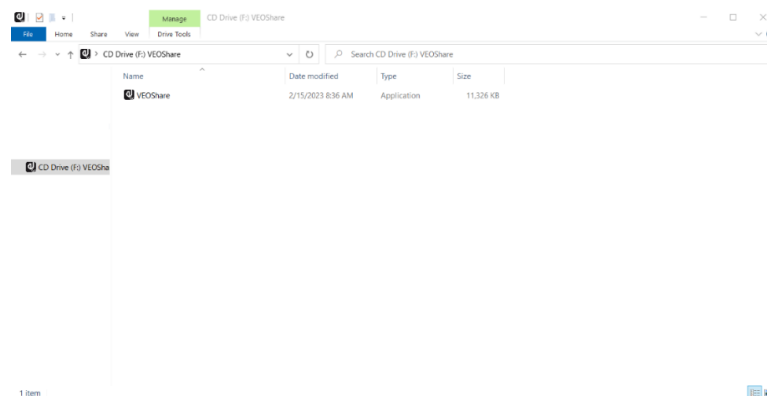

2. Copy VEOShare app to local storage.

 The **first time that user connects laptop with VEO-SWC44 over WiFi**, when the application detects that unit is connected to camera, mic&speaker, it **will pop out the message bar indicating to install a virtual driver to activate USB over WiFi function**, in order to start video conferencing via VEO-SWC44, as below steps.

 The **virtual driver is only for video conferencing**, user can normally mirror desktop without it installed. If the VEO-SWC44 is not connected with camera, mic&speaker, it will not pop out message to install driver, user could mirror desktop as well.

Home	Web UI	Web UI Setting	Network Settings	Display & Audio	Moderator Control	System Settings	Security Settings	Firmware Upgrade	Other Settings	UCC Device Manager	TECHNICAL DATA
HW	Management & Configuration	PRECAUTIONS	PACKAGE CONTENTS	DESCRIPTION & FEATURES	INSTALL & CONNECT	START-UP & OPERATION	FIRMWARE UPDATE	PANEL FUNCTIONS & WIRELESS TRANSMITTERS	TROUBLESHOOTING		

- **Starting and Operating VEOShare app**

Once VEOShare app is copied into the local storage of the Laptop, it is ready for use.

1. **Open VEOShare app** on the source device. The available VEO-SWC44 switcher will show if source device and the switcher are on the same network.

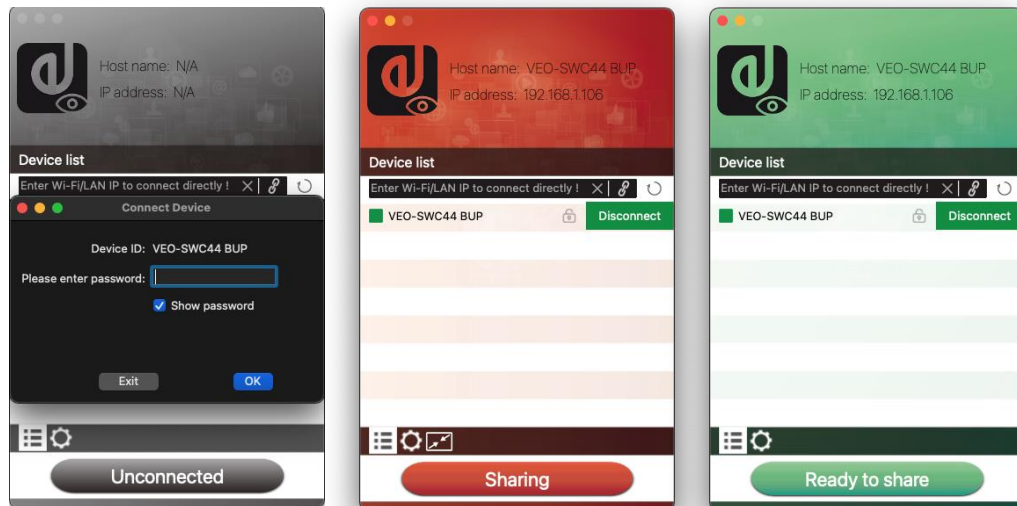

2. **Connect the laptop to WiFi network displayed on the Home Screen** (“Guest”, “Staff”), or connect to the LAN on the network **using a network cable**.
3. **Double-click the VEOShare app**. A list of all available VEO-SWC44 base units in the same network will be displayed. select the device to connect to. The connections are password protected (lock icon).
4. Enter **VEO-SWC44 password** and click **“connect”**, the **system is ready to share**.

Manually connection by entering the name (SSID) or IP address is also possible if base unit is not appearing. (click icon).

5. VEOShare app layout will turn to green. **Clicking “Ready to share” will start sharing content** with the main display connected to the VEO-SWC44 HDMI output. When window colour is static red, the desktop is mirroring to the main screen.
6. Clicking **“Sharing” will stop sharing content**. Window colour is static green again.

Home	Web GUI Setting	Network Settings	Display & Audio	Moderator Control	System Settings	Security Settings	Firmware Upgrade	Other Settings	UCC Device Manager	TECHNICAL DATA
HW	Web GUI	PRECAUTIONS	INSTALL & CONNECT	START-UP & OPERATION	FIRMWARE UPDATE	PANEL FUNCTIONS & WIRELESS TRANSMITTERS	TROUBLESHOOTING			
	Management & Configuration	PACKAGE CONTENTS	DESCRIPTION & FEATURES							

- VEOShare Settings

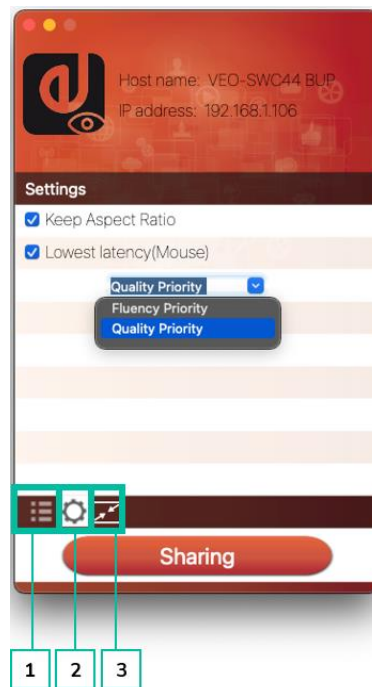

1. Device List

2. Options

- **Extended Screen:**

Transfers extended desktop of active source.

The primary screen (1) is displayed on the laptop and the virtually extended screen (2) is displayed on the main screen. If the PC has already connected an extended screen (3), the extended screen (2) will always be displayed on the main screen.

For the first time use of function “Extended Screen”, click the “Extended Screen”, will pop out a message to indicate the installation of the “ExtendedDisplay” driver. Click “yes” to continue, once installed, the Extended screen function is ready to use.

If **Extended Screen** feature is **selected**, **Windows automatically switches to “Extended Mode”**. If you stop the transfer with “VEOShare” (Pause), Windows remains in " Extended Mode" until pressing "Windows key + P" on the laptop to select the "PC screen only" mode.

In **macOS**, **Extended desktop (“Use a Separate Display”)** only via **AirPlay**, when activated for Display on VEOShare app.

Home	Web UI Setting	Network Settings	Display & Audio	Moderator Control	System Settings	Security Settings	Firmware Upgrade	Other Settings	UCC Device Manager	TECHNICAL DATA
HW	Management & Configuration	DESCRIPTION & FEATURES	INSTALL & CONNECT	START-UP & OPERATION	FIRMWARE UPDATE	PANEL FUNCTIONS & WIRELESS TRANSMITTERS	TROUBLESHOOTING			
	PRECAUTIONS	PACKAGE CONTENTS								

- **Keep Aspect Ratio:**

This parameter will apply the original aspect ratio of the main screen.

- **Stream Mode:**

This parameter will adapt the performance to fit the desired application:

- **Fluency Priority:** (Default) Image transmission delay is small, image resolution will be lower, suitable for PPT presentation mode.
- **Quality Priority:** The image resolution is relatively high, but when the image content is complex, the transmission delay will be relatively larger, suitable for watching video.

- **Lowest Latency Mouse:**

The setting is applied individually on every VEOShare host device only. The shape of mouse-pointer is equal to the shape in the application used. This parameter significantly improves the mouse response (approximate latency is under 20ms).

- **Volume Slider:**

This parameter will adjust the playback volume of the main screen when presentation mode is in use.

 **Not available in macOS**

3. Full Screen

By clicking full screen icon  on PC UI interface, or long press the wireless transmitter, the content will be full displayed on screen. Click or short press again, will get the screen back to quad view mode.

5.3.3 Screen Sharing using Airplay

On iOS and macOS devices a user can stream his screen or sound wirelessly to VEO-SWC44 base unit via Airplay protocol.

1. Connect the iOS or macOS device to the same WiFi network that VEO-SWC44 is connected to.
2. Show the control centre. Click the Airplay icon  on your iOS and macOS device and select the target VEO-SWC44 to start sharing content with the VEO-SWC44.

Home	Web UI	WebGUI Setting Management & Configuration	Network Settings	Display & Audio	Moderator Control	System Settings	Security Settings	Firmware Upgrade	Other Settings	UCC Device Manager	TECHNICAL DATA
HW	Web UI	PRECAUTIONS	PACKAGE CONTENTS	DESCRIPTION & FEATURES	INSTALL & CONNECT	START-UP & OPERATION	FIRMWARE UPDATE	PANEL FUNCTIONS & WIRELESS TRANSMITTERS	TROUBLESHOOTING		

5.3.4 Screen Sharing using Miracast

- **Android Devices**

1. **WiFi must be enabled.**
2. **Click the Wireless projection icon on the control centre.**

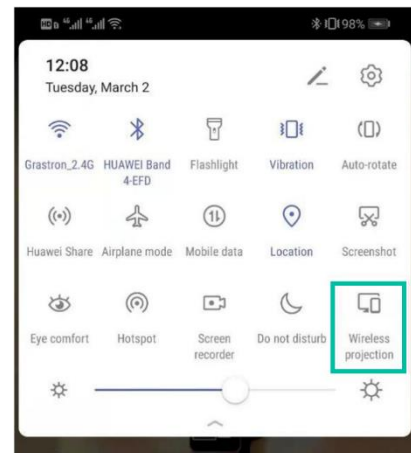

3. **Select VEO-SWC44 SSID and click to connect.**

! Under **Security Level 1 mode**, there is **no need to enter password** to connect. Under **Security level 2 and Security level 3 mode**, it will **need to enter password** on VEO-SWC44 Home Screen to connect and start casting.

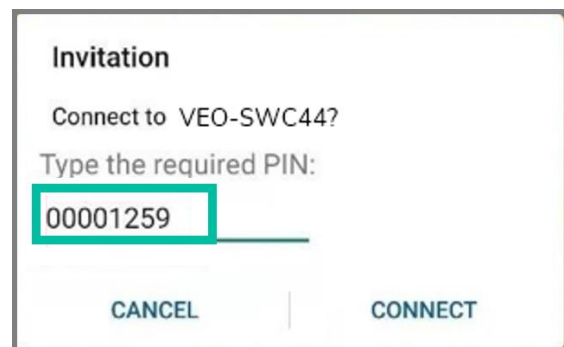

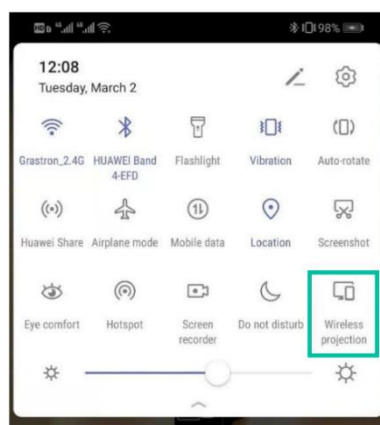

4. **After entering password, your mobile content will be shown on the display.**
5. **Click the “Wireless projection” icon again to stop mirroring.**

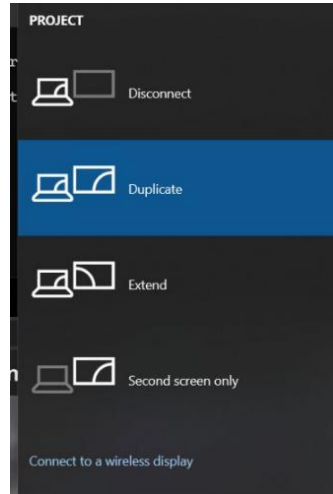

Home	Web UI Setting	Network Settings	Display & Audio	Moderator Control	System Settings	Security Settings	Firmware Upgrade	Other Settings	UCC Device Manager	TECHNICAL DATA
HW	Management & Configuration	DESCRIPTION & FEATURES	INSTALL & CONNECT	START-UP & OPERATION	FIRMWARE UPDATE	PANEL FUNCTIONS & WIRELESS TRANSMITTERS	TROUBLESHOOTING			
	PRECAUTIONS	PACKAGE CONTENTS								

- PC
 1. **WiFi must be enabled and connected** to the same network as VEO-SWC44 base unit.
 2. Press  + P and then click **“Connect to a wireless display”** in the pop-up window.



 Under **Security Level 1 mode**, there is **no need to enter password** to connect. Under **Security level 2 and Security level 3 mode**, it will **need to enter password** on VEO-SWC44 Home Screen to connect and mirror. After entering password, your mobile content will be shown on display.

Home	Web UI	Web UI Setting Management & Configuration	Network Settings	Display & Audio	Moderator Control	System Settings	Security Settings	Firmware Upgrade	Other Settings	UCC Device Manager	TECHNICAL DATA
HW	PRECAUTIONS	PACKAGE CONTENTS	DESCRIPTION & FEATURES	INSTALL & CONNECT	START-UP & OPERATION	FIRMWARE UPDATE	PANEL FUNCTIONS & WIRELESS TRANSMITTERS	TROUBLESHOOTING			

5.3.5 Screen Sharing using Chromecast

- Android Devices

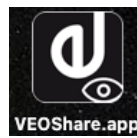

1. Download VEOShare application ([see chapter WebGUI Setting Management & Configuration](#)).
2. Connect your Android device to one of the displayed WiFi networks.
3. Open the VEOShare application in the Android device, and then click the device list refresh button.

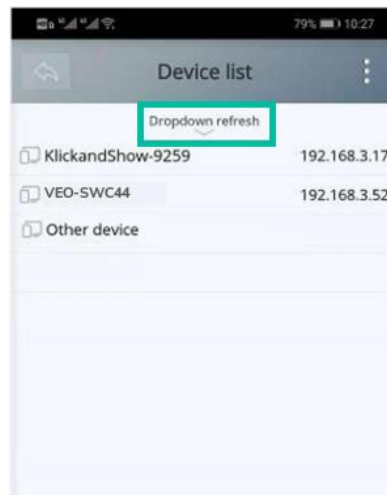

4. Select the VEO-SWC44 to connect to and enter password to start screen sharing.



5. Click again the button “Share Screen” to stop mirroring.

Home	Web 5	WebGUI Setting Management & Configuration	Network Settings	Display & Audio	Moderator Control	System Settings	Security Settings	Firmware Upgrade	Other Settings	UCC Device Manager	TECHNICAL DATA
HW	Web 5	PRECAUTIONS	PACKAGE CONTENTS	DESCRIPTION & FEATURES	INSTALL & CONNECT	START-UP & OPERATION	FIRMWARE UPDATE	PANEL FUNCTIONS & WIRELESS TRANSMITTERS	TROUBLESHOOTING		

- PC
 1. Connect the PC and VEO-SWC44 on the same network.
 2. Open Chrome browser.
 3. Click “cast” to connect Chromecast function.

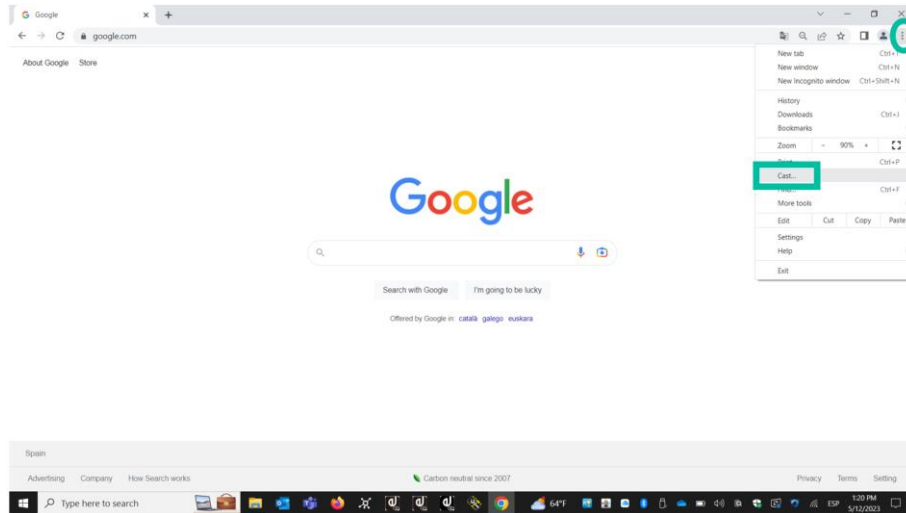

4. Click VEO-SWC44 SSID to start sharing content.

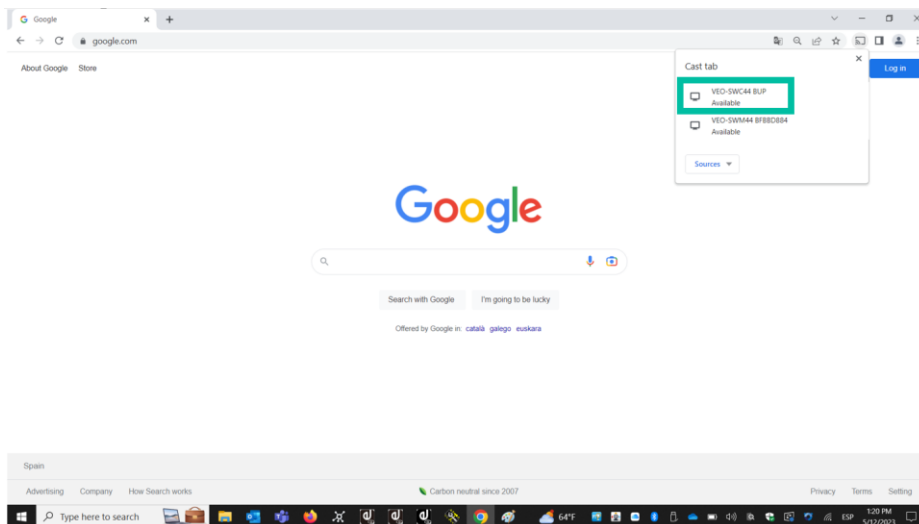

5. Click VEO-SWC44 SSID again to stop sharing content.

Home	Web UI	WebUI Setting	Network Settings	Display & Audio	Moderator Control	System Settings	Security Settings	Firmware Upgrade	Other Settings	UCC Device Manager	TECHNICAL DATA
HW	Management & Configuration	DESCRIPTION & FEATURES	INSTALL & CONNECT	START-UP & OPERATION	FIRMWARE UPDATE	PANEL FUNCTIONS & WIRELESS TRANSMITTERS	TROUBLESHOOTING				
PRECAUTIONS	PACKAGE CONTENTS										

5.4 Wireless Conferencing Mode

VEO-SWC44 allows to conduct a video conference using the room USB conferencing devices over WiFi.

1. Connect the USB conferencing devices to the VEO-SWC44 USB ports. Camera and microphone icons will appear on VEOShare control bar.
 - **White icons:** indicate the USB camera and speaker/mic are connected.
 - **Green icons:** indicate the USB camera and speaker/mic are connected and in use by any given application.

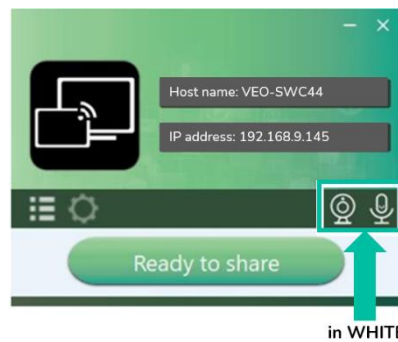

2. Launch Videoconferencing application.

- Select “Virtual Meeting Camera” as video device.

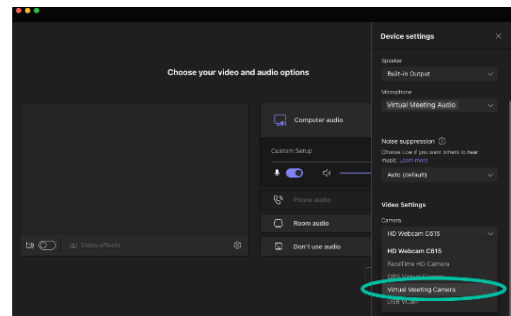

- For **Speaker**, select “Virtual Meeting Audio”.
- For **Microphone**, select “Virtual Meeting Audio”, too.

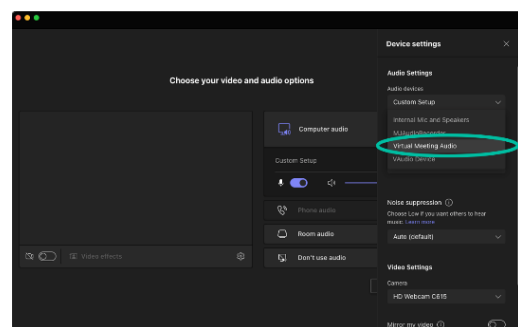

3. Clicking “Ready to share” button in VEOShare application will start wireless conferencing sharing.



Home	Web UI Setting	Web UI Management & Configuration	Network Settings	Display & Audio	Moderator Control	System Settings	Security Settings	Firmware Upgrade	Other Settings	UCC Device Manager	TECHNICAL DATA
HW	PRECAUTIONS	PACKAGE CONTENTS	DESCRIPTION & FEATURES	INSTALL & CONNECT	START-UP & OPERATION	FIRMWARE UPDATE	PANEL FUNCTIONS & WIRELESS TRANSMITTERS	TROUBLESHOOTING			

5.5 Moderator Preview Window

VEO-SWC44 includes a **moderator preview window** that will let the user choose which of the online devices is displayed on the main screen, turn on and off wireless casting on any device or control volume playback.



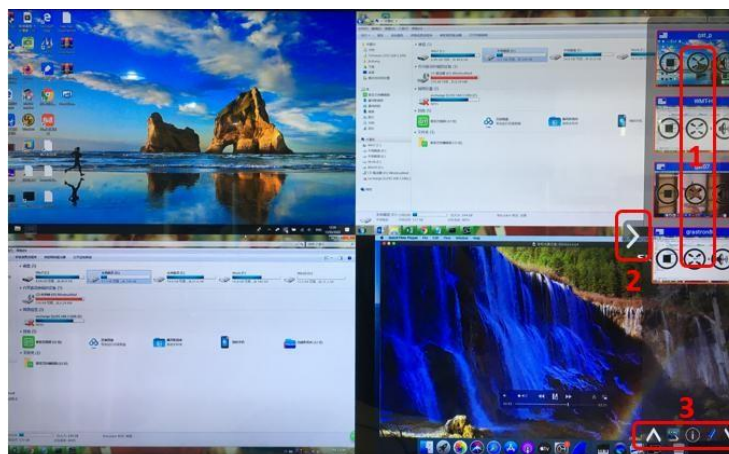

! In order to show, hide or manage moderator tab, a **USB HID compatible device connected to the VEO-SWC44 base unit is necessary** (Touchscreen, mouse...).

Preview windows of all connected transmitters, VEOShare app users and Airplay / Miracast / Chromecast screen sharing devices will appear on the tab. Various window prefixed layouts can be selected on Moderator section of WEB settings, see chapter [Moderator Layout](#).

💡 **Four users are allowed to present simultaneously and 16 more can be connected to VEO-SWC44 base unit in standby.**



Moderator Preview Control Buttons:

- 1  Click to start transmission.
-  Click to stop mirroring the current participant.
-  Click to make this device full screen on main screen.
-  Click to adjust the volume of connected participant.
- 2 Arrow to show moderator tab.
- 3 Whiteboard and Annotation. For further details, see below.

Home	Web UI	Web UI Setting Management & Configuration	Network Settings	Display & Audio	Moderator Control	System Settings	Security Settings	Firmware Upgrade	Other Settings	UCC Device Manager	TECHNICAL DATA
HW	PRECAUTIONS	PACKAGE CONTENTS	DESCRIPTION & FEATURES	INSTALL & CONNECT	START-UP & OPERATION	FIRMWARE UPDATE	PANEL FUNCTIONS & WIRELESS TRANSMITTERS	TROUBLESHOOTING			

5.6 Whiteboard & Annotation





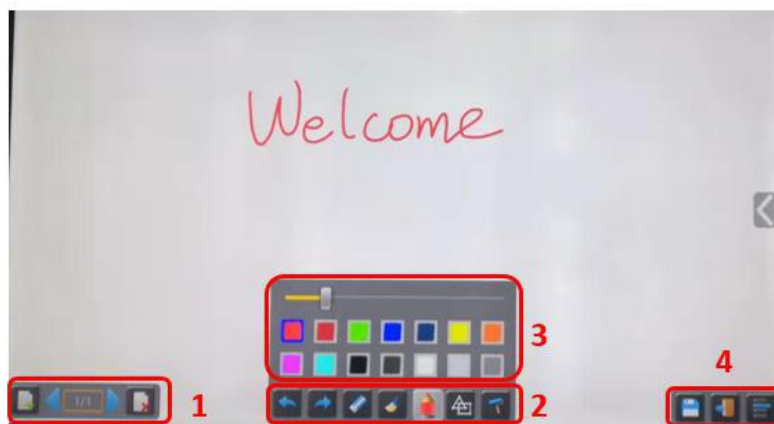

Whiteboard and Annotation requires an **USB HID compatible device**, such as interactive white board, touch screen or mouse. There are two different modes:

5.6.1 Whiteboard



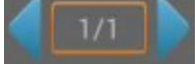



A white board is brought up that **will let the user to write notes, draw content**. It allows different figures, colours and background. To start Whiteboard, mode **click**  **on the Home Screen.**

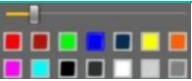

Use the toolbar to select one of the following functions.

ID	Icons	Function
Tool bar 1		Add an empty page.
		Delete current page.
		Display previous or next page.
Tool bar 2		Undo: one step backward in changes.
		Redo: one step forward in changes.
		Erase part of drawings or annotation, change diameter by a longer tap.
		Clear the entire drawing/writing on the screen.

- Home
- Web UI Management & Configuration
- Web UI Setting
- PRECAUTIONS
- PACKAGE CONTENTS
- DESCRIPTION & FEATURES
- INSTALL & CONNECT
- START-UP & OPERATION
- FIRMWARE UPDATE
- PANEL FUNCTIONS & WIRELESS TRANSMITTERS
- TROUBLESHOOTING
- TECHNICAL DATA
- HW
- Web UI
- Network Settings
- Display & Audio
- Moderator Control
- System Settings
- Security Settings
- Firmware Upgrade
- Other Settings
- UCC Device Manager

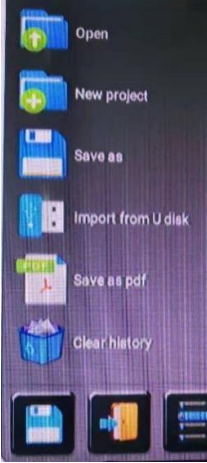
		Pen allows writing/drawing in different colours.
		Draw basic geometric shapes.
		Select colour of board, the drawing will be kept.
Tool bar 3		will pop up, when “Pen” or Draw shape or Select colour of board is selected, for individual change of size of Pen, Shape or colour.
Tool bar 4		Save the current screenshot on local storage (PNG+WMN).
		Close Whiteboard to go back to Home Screen, actual project can be saved on local storage (WMN).
File options	 	<ul style="list-style-type: none"> • Open WMN-file from local storage and continue/edit an older project. • New project • Save as WMN on local storage in unit, it will be erased after POWER-OFF. • Import from U disk stored project (WMN). • All pages are saved as PDF on local storage. • Clear history – delete all whiteboard & annotation files on local storage.

	HW	Web UI	Web UI Setting	Network Settings	Display & Audio	Moderator Control	System Settings	Security Settings	Firmware Upgrade	Other Settings	UCC Device Manager	TECHNICAL DATA
	PRECAUTIONS	PACKAGE CONTENTS	DESCRIPTION & FEATURES	INSTALL & CONNECT	START-UP & OPERATION	FIRMWARE UPDATE	PANEL FUNCTIONS & WIRELESS TRANSMITTERS	TROUBLESHOOTING				
	Management & Configuration											









5.6.2 Annotation

Allows the user to **draw or write annotations in overlay within the presented content of the active sharing devices**. It allows different figures, colours, and background.

To start Annotation mode, click  on the Home Screen.



Use the toolbar to select one of the following functions.

ID	Icons	Function
Tool bar 1		Undo: one step backward in changes
		Redo: one step forward in changes
		Erase part of drawings or annotation, change diameter by a longer tap
		Clear the entire drawing/writing on the screen
		Pen allows writing/drawing in different colours
		Draw basic geometric shapes
		Select colour of board, the drawing will be kept
		Close Whiteboard to go back to Home Screen, actual project can be saved on local storage (WMN).
		Save the current screenshot on local storage (PNG+WMN).

Home	Web GUI	WebGUI Setting Management & Configuration	Network Settings	Display & Audio	Moderator Control	System Settings	Security Settings	Firmware Upgrade	Other Settings	UCC Device Manager	TECHNICAL DATA
HW	PRECAUTIONS	PACKAGE CONTENTS	DESCRIPTION & FEATURES	INSTALL & CONNECT	START-UP & OPERATION	FIRMWARE UPDATE	PANEL FUNCTIONS & WIRELESS TRANSMITTERS	TROUBLESHOOTING			

- **Download the Drawings to Connected Users**

When saving a screen of Whiteboard or Annotation modes into internal storage of VEO-SWC44, scanning the QR code or entering the given IP address in a browser will allow the user to download the saved files.

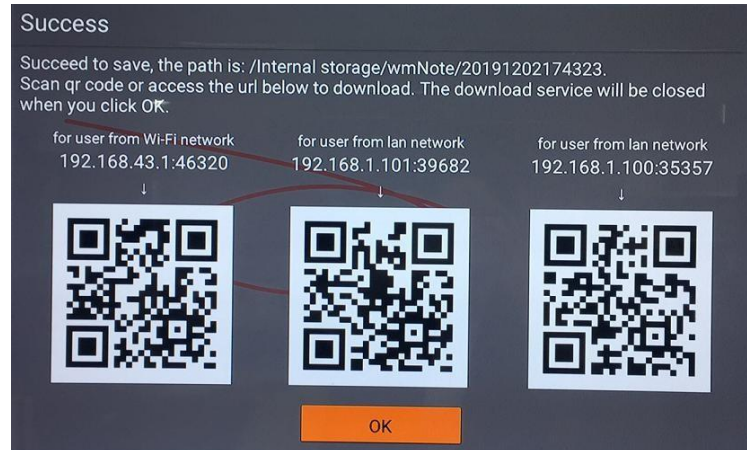

 **Data can be copied to a USB disk and after connecting it to the VEO-SWC44, it can be imported into the Whiteboard section with "Import from U disk".**

HW	Web UI	Management & Configuration	Network Settings	Display & Audio	Moderator Control	System Settings	Security Settings	Firmware Upgrade	Other Settings	UCC Device Manager	TECHNICAL DATA
PRECAUTIONS	PACKAGE CONTENTS	DESCRIPTION & FEATURES	INSTALL & CONNECT	START-UP & OPERATION	FIRMWARE UPDATE	PANEL FUNCTIONS & WIRELESS TRANSMITTERS	TROUBLESHOOTING				

6. WebGUI SETTING MANAGEMENT & CONFIGURATION

To access VEO-SWC44 WEB settings it is necessary to enter the base unit IP address in an internet browser. The first page displayed will let the user download VEOShare app for all platforms.

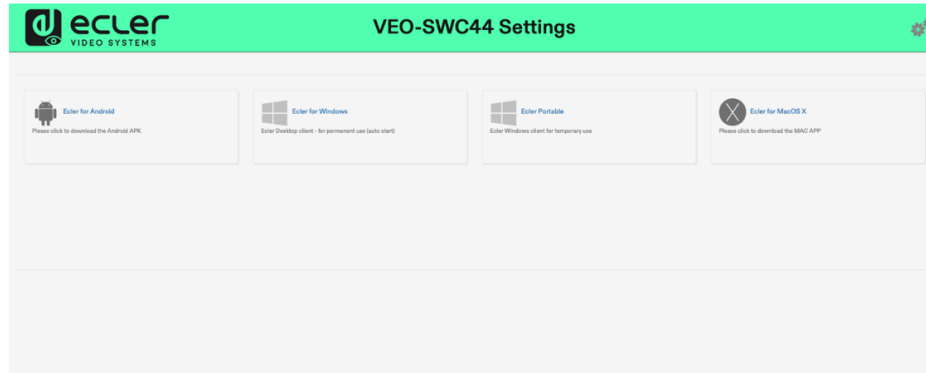

If VEO-SWC44 is on “Wireless direct Mode”, first access VEO-SWC44 SSID and enter current password on Home Screen page. IP address is 192.168.43.1. [For further information on how to configure network, see chapter Network Settings.](#)

1. Click  on the top right corner to enter into **WEB Settings** menu.

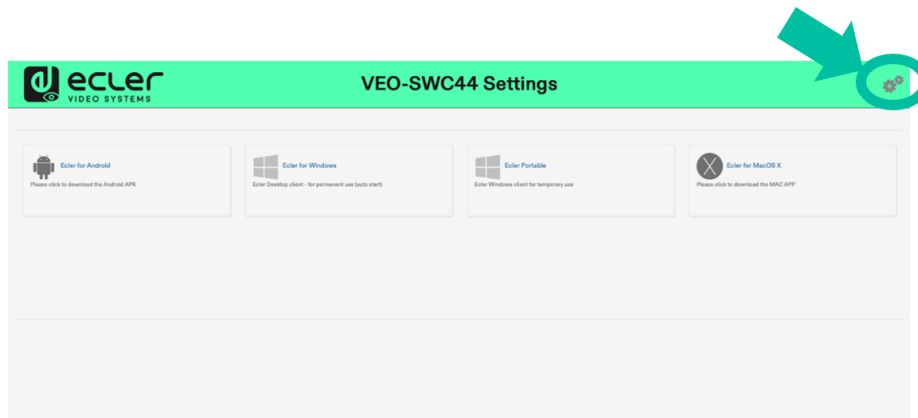

2. Login page will appear.

Default user: admin

Default password: admin

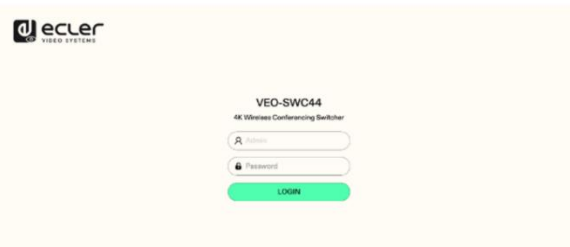

Entering Login credentials will give access to the main **WEB settings** page where it will be able to configure Network settings, Display & Audio, Moderator control, System settings, Security settings, Firmware upgrade, Other settings, About device.

Home	Web	WebGUI Setting Management & Configuration	Network Settings	Display & Audio	Moderator Control	System Settings	Security Settings	Firmware Upgrade	Other Settings	UCC Device Manager	TECHNICAL DATA
HW	Web	PRECAUTIONS	PACKAGE CONTENTS	DESCRIPTION & FEATURES	INSTALL & CONNECT	START-UP & OPERATION	FIRMWARE UPDATE	PANEL FUNCTIONS & WIRELESS TRANSMITTERS	TROUBLESHOOTING		

6.1 Network Settings

To take the full benefit of VEO-SWC44 features, it is important to configure and integrate the base unit network settings according to the needs of the application required. VEO-SWC44 includes two independent wired LAN and a WiFi network card.

The following sections can be accessed in Network Settings page:

6.1.1 Wireless Network

This section allows the user to set the network working mode of VEO-SWC44.

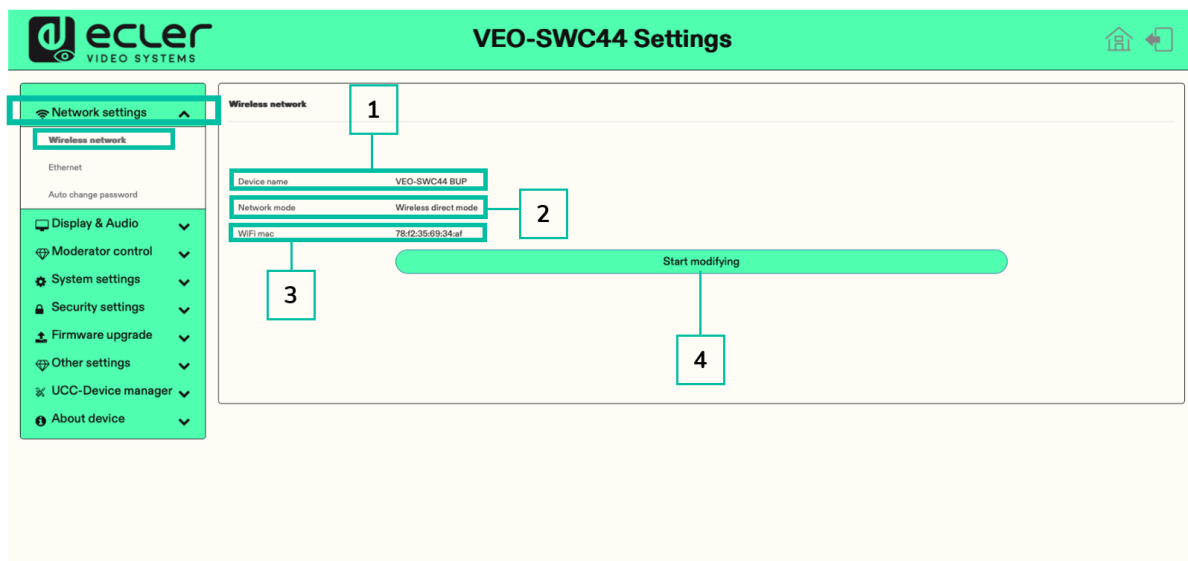

1. **Device name:** this parameter indicates current name assigned to VEO-SWC44
2. **Network mode:** this parameter tells the user which network working mode is currently configured.
3. **WiFi Mac:** this parameter shows the MAC address assigned to the VEO-SWC44 network card.
4. **Start modifying:** Click to enter a network setup wizard is available to change network working mode to properly integrate VEO-SWC44 into an existing wireless infrastructure.

⚠ Any change to Network mode will need VEO-SWC44TH and VEO-SWC44TU to be paired again with VEO-SWC44 base unit.

Home	Web UI Settings
HW	Web UI Settings
PRECAUTIONS	Management & Configuration
PACKAGE CONTENTS	DESCRIPTION & FEATURES
INSTALL & CONNECT	INSTALL & CONNECT
START-UP & OPERATION	START-UP & OPERATION
FIRMWARE UPDATE	FIRMWARE UPDATE
PANEL FUNCTIONS & WIRELESS TRANSMITTERS	PANEL FUNCTIONS & WIRELESS TRANSMITTERS
TROUBLESHOOTING	TROUBLESHOOTING
TECHNICAL DATA	TECHNICAL DATA

6.1.1.1 Network Modes Configuration

- 1. Device Name:** Enter a device name for the Base-unit VEO-SWC44. Allowed characters are: "a-z", "A-Z", "0-9", "-", "_", and "space", then Click "Next step".

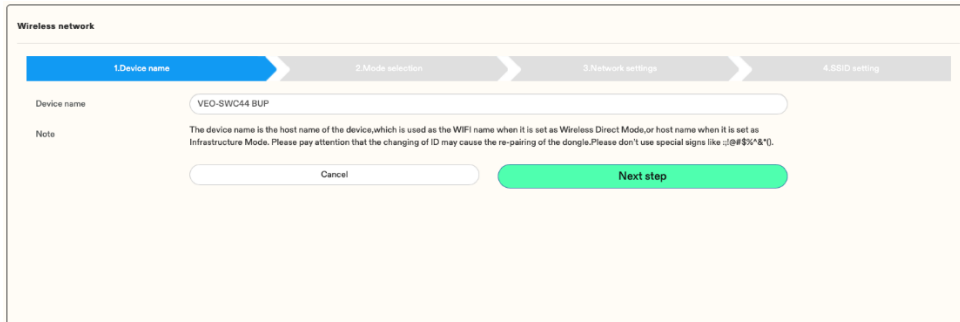

- 2. Mode Selection:** Select the desired network mode and click "Next Step".

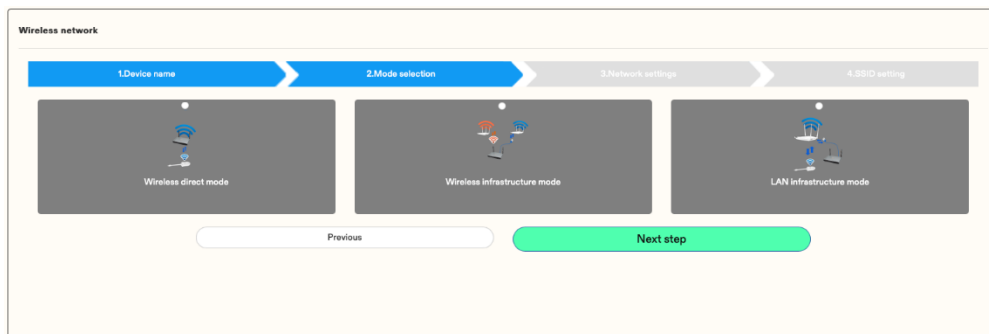

Home	Web UI	Web UI Setting	Network Settings	Display & Audio	Moderator Control	System Settings	Security Settings	Firmware Upgrade	Other Settings	UCC Device Manager	TECHNICAL DATA
HW	Management & Configuration	PRECAUTIONS	DESCRIPTION & FEATURES	INSTALL & CONNECT	START-UP & OPERATION	FIRMWARE UPDATE	PANEL FUNCTIONS & WIRELESS TRANSMITTERS	TROUBLESHOOTING			

- **Wireless Direct Mode**

VEO-SWC44 unit starts up in the default standalone “Wireless direct mode” configuration after a factory reset or the first time it’s being used. The base unit creates its own wireless access point, which all devices need to connect in order to share content with base unit. **This option is best for temporary operation, small installations, and rooms without network access** or networks that do not allow network access for Guests, due to strict security concerns, and are completely separated from the corporate network.

Under this mode, VEO-SWC44 can work without any other wireless network configuration. Just pair VEO-SWC44TH / VEO-SWC44TU with VEO-SWC44 base unit, connect to VEO-SWC44 internal hotspot and open VEOShare app or use Airplay, Miracast or Chromecast wireless casting protocols.

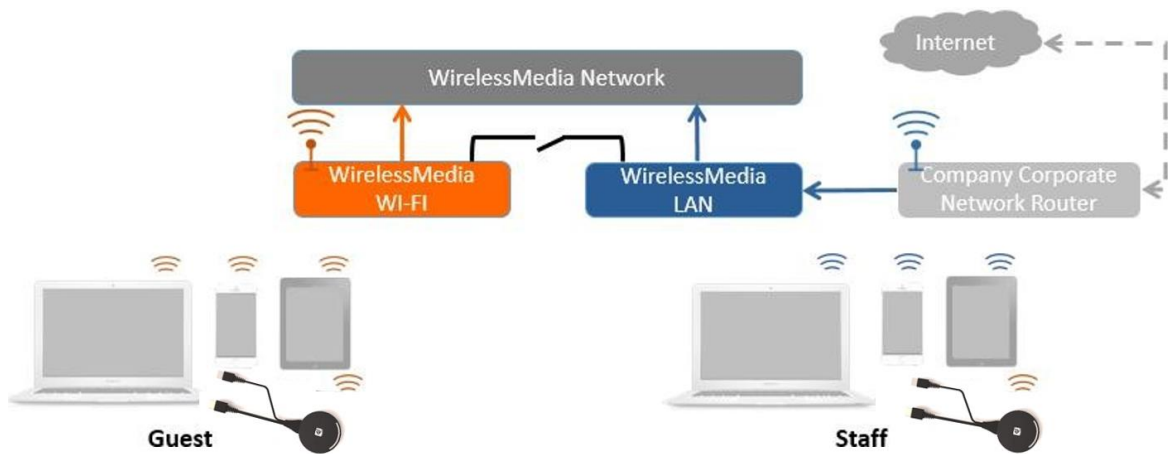

1. Click “Next step” to Set up WiFi access point.

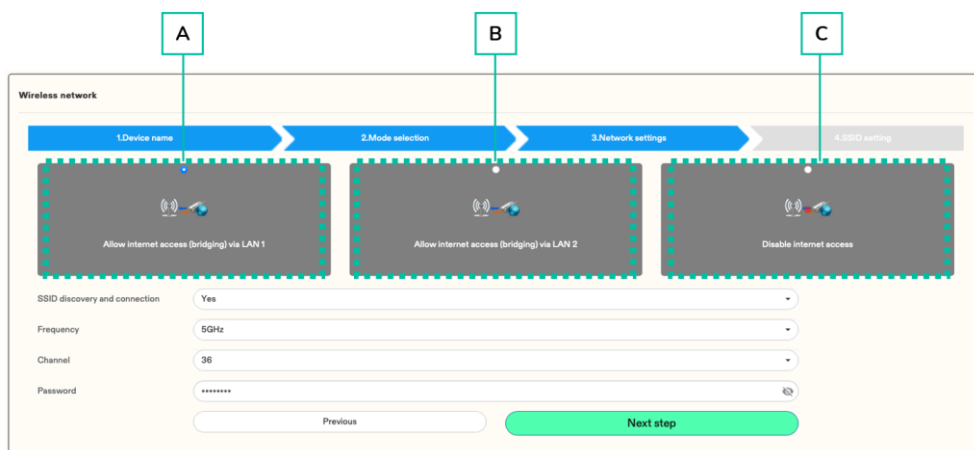

Home	Web UI	Web UI Setting	Network Settings	Display & Audio	Moderator Control	System Settings	Security Settings	Firmware Upgrade	Other Settings	UCC Device Manager	TECHNICAL DATA
HW	Management & Configuration	PRECAUTIONS	PACKAGE CONTENTS	DESCRIPTION & FEATURES	INSTALL & CONNECT	START-UP & OPERATION	FIRMWARE UPDATE	PANEL FUNCTIONS & WIRELESS TRANSMITTERS	TROUBLESHOOTING		

- There are **three ways of connecting to Internet** through VEO-SWC44 in “Wireless Direct Mode”:
 - a) **Allow internet access (bridging) via LAN 1:** the source device is able to connect to Internet if LAN1 port is available.
 - b) **Allow internet access (bridging) via LAN 2:** the source device is able to connect to Internet if LAN2 port is available.
 - c) **Disable internet access:** the source device is not able to connect to Internet if this mode is activated.
- **SSID discovery and connection:** Select “Yes” to make VEO-SWC44 SSID visible and “No” to hide it.
- **Frequency:** Click to select 2.4 GHz or 5 GHz WiFi frequency. Default is 5 GHz.
- **Channel:** Click to select the WiFi channel. Default is 5 GHz, Auto. If the WiFi channel is changed, no new pairing of the wireless transmitter is necessary.
 - **2.4 GHz frequency band:** channels 1, 2, 3, 4, 5, 6, 7, 8, 9, 10, 11,
 - **5 GHz frequency band:** no need to choose 5G channel, system will choose proper channel automatically. Default is 5 GHz, channel: Auto.
 - **Default channel (USA area):** 36,40,44,48 or 149,153,157, 161. Four channels will be opened at the same time, system will automatically choose proper channel from them.
 - **Default channel (European area):** 36,40,44,48.
 - **Default channel (China):** 149,153,157,161.
- **Password:** Click in the input field to fill out the appropriate password with length of 8 characters.

2. Click “Next step” to edit or change GUEST and STAFF network SSID. This information will be displayed at Home Screen of VEO-SWC44.

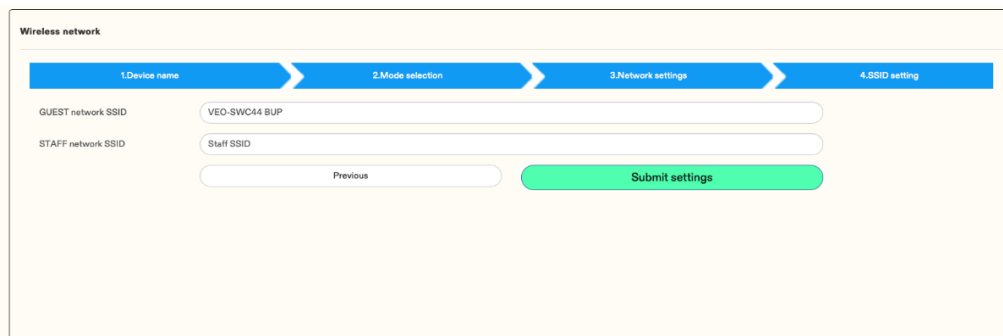

3. Click “Submit settings” to finish configuration. Then, pair wireless transmitters with the VEO-SWC44 again.

Home	Web UI	Web UI Setting	Network Settings	Display & Audio	Moderator Control	System Settings	Security Settings	Firmware Upgrade	Other Settings	UCC Device Manager	TECHNICAL DATA
HW	Web UI	PRECAUTIONS	PACKAGE CONTENTS	DESCRIPTION & FEATURES	INSTALL & CONNECT	START-UP & OPERATION	FIRMWARE UPDATE	PANEL FUNCTIONS & WIRELESS TRANSMITTERS	TROUBLESHOOTING		

- **Wireless Infrastructure mode**

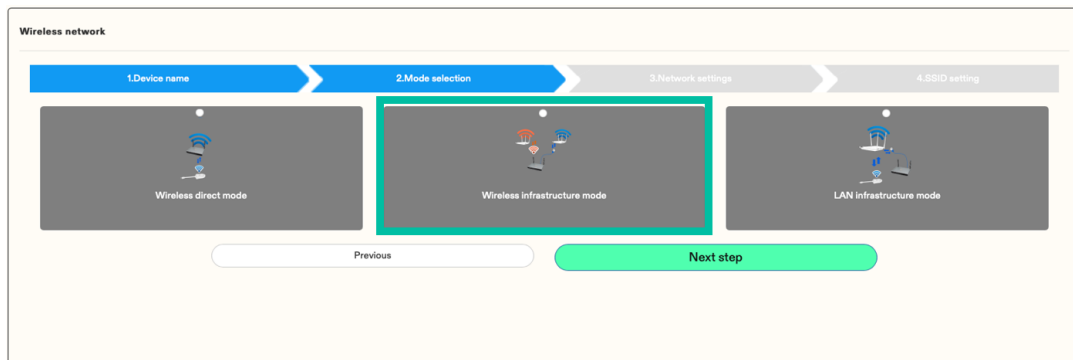

VEO-SWC44 can simultaneously connect to a wired and a wireless network. The segmented dual network of VEO-SWC44 provides two separated routing ways to connect to the base unit at the same time. **This is very useful for organizations, which have a wireless “Guest” network for external visitors and a wired “Staff” network for their employees.** Guest-users are not able to access any resource on the internal network of the company. Guest and Staff have internet access.

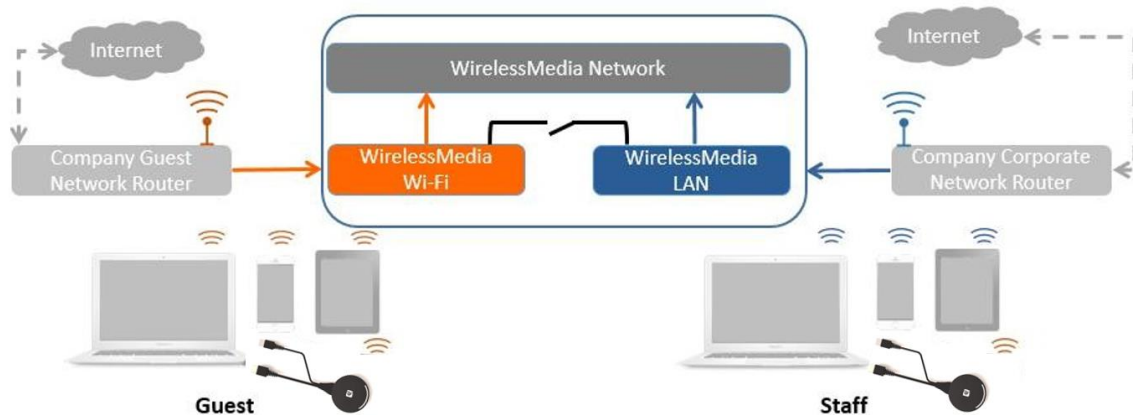

Under this mode, users will be able to present with VEO-SWC44TH / VEO-SWC44TU / VEOCast / Native Wireless protocols (Airplay, Miracast, Chromecast). VEO-SWC44TH / VEO-SWC44TU will be connected to the WiFi access point of “Guest” network, which in turn is connected to the internal WiFi access point of VEO-SWC44. (They can also be configured to connect to the enterprise’s access point.) **Mobile devices users will stay connected to their current network** thus have access to their normal corporate environment as well as Internet access.

Home	Web	WebGUI Setting	Network	Display & Audio	Moderator Control	System Settings	Security Settings	Firmware Upgrade	Other Settings	UCC Device Manager	TECHNICAL DATA
HW	Management & Configuration	DESCRIPTION & FEATURES	INSTALL & CONNECT	START-UP & OPERATION	FIRMWARE UPDATE	PANEL FUNCTIONS & WIRELESS TRANSMITTERS	TROUBLESHOOTING				
PRECAUTIONS	PACKAGE CONTENTS										

1. Click “Next step” to enter the configuration of this the network mode.

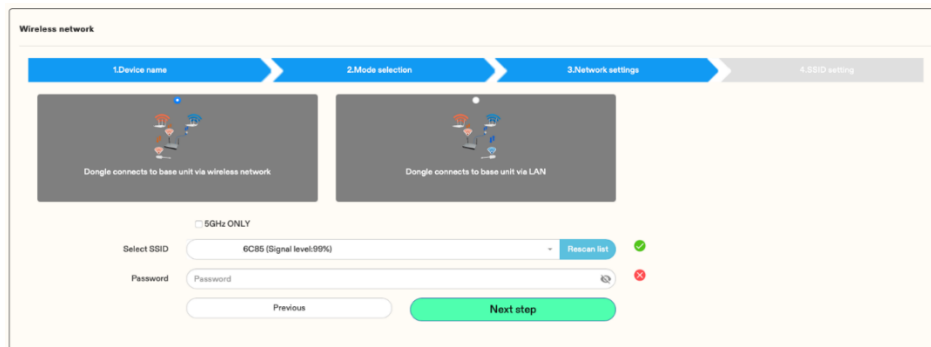

2. Choose a wireless network which is separate from the company LAN network for guest users.

- **Select SSID:** Choose a wireless network to connect to VEO-SWC44 for guest.
- **Password:** enter password to connect the VEO-SWC44 to the guest network.

3. Click “Next step” to edit or change GUEST and STAFF network SSID.

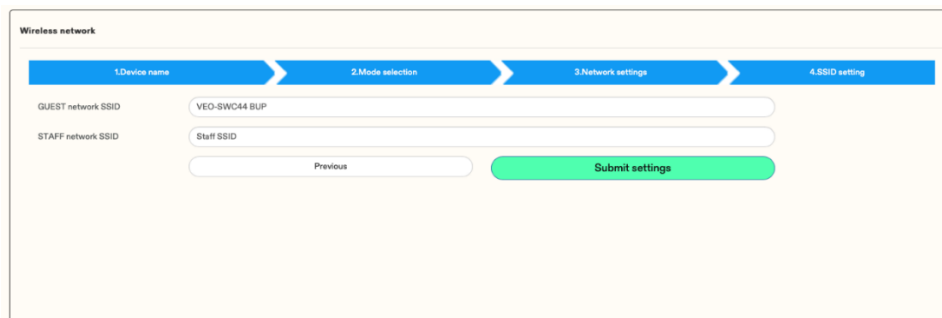

WiFi name of guest and staff will be displayed on Home Screen after “Submit settings”.

4. Click “Submit settings” to finish configuration. Then pair wireless transmitters with the VEO-SWC44 again.

5. Choose a LAN network which is used for the company staff users.

Usually in this mode, **wireless transmitter** is **paired for internal staff usage**.

- **Select SSID:** Choose a wireless network to connect to VEO-SWC44 for guest.
- **Password:** enter password to connect the VEO-SWC44 to the guest network.
- **Select wireless transmitter SSID:** choose the same LAN network which VEO-SWC44 connects, to pair the wireless transmitter.
- **Password:** enter password of the LAN network.

Home	Web UI	Web UI Setting	Network Settings	Display & Audio	Moderator Control	System Settings	Security Settings	Firmware Upgrade	Other Settings	UCC Device Manager	TECHNICAL DATA
HW	Management & Configuration	PRECAUTIONS	DESCRIPTION & FEATURES	INSTALL & CONNECT	START-UP & OPERATION	FIRMWARE UPDATE	PANEL FUNCTIONS & WIRELESS TRANSMITTERS	TROUBLESHOOTING			

6. Click “Next step” to edit or change GUEST and STAFF network SSID.

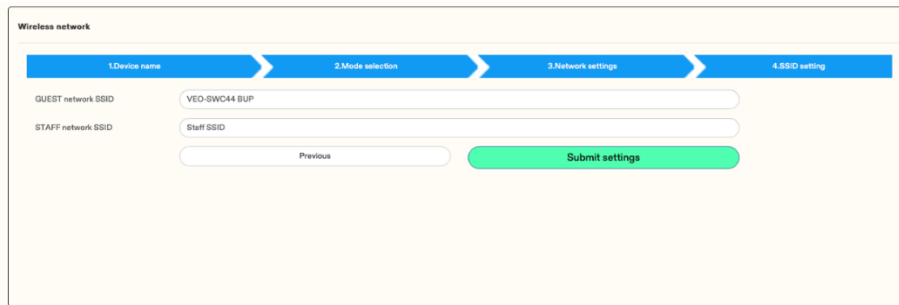

- LAN Infrastructure Mode

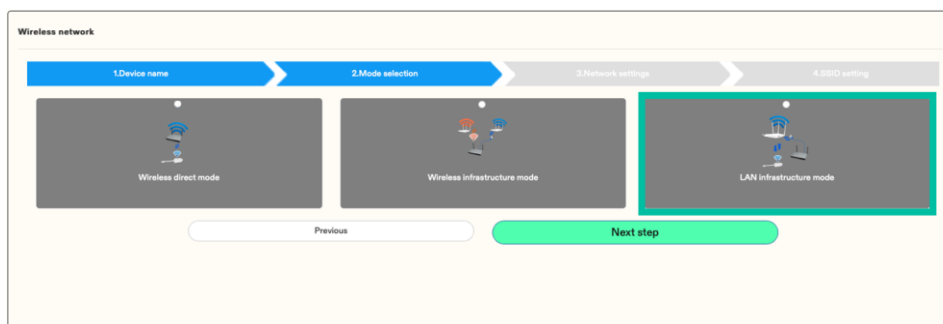

In this configuration the built-in WiFi access point of VEO-SWC44 is disabled.

VEO-SWC44TH / VEO-SWC44TU and mobile devices can connect to the secured wireless access point of the company network. The VEO-SWC44 base unit will be connected via network cable to the wired of the company network.

The Staff users will be able to connect to their usual access point of Company network, without the need to change the WiFi as long as both networks are on the same range.

! VEO-SWC44TH / VEO-SWC44TU will be automatically paired to the Staff access point, and not to VEO-SWC44 base unit.

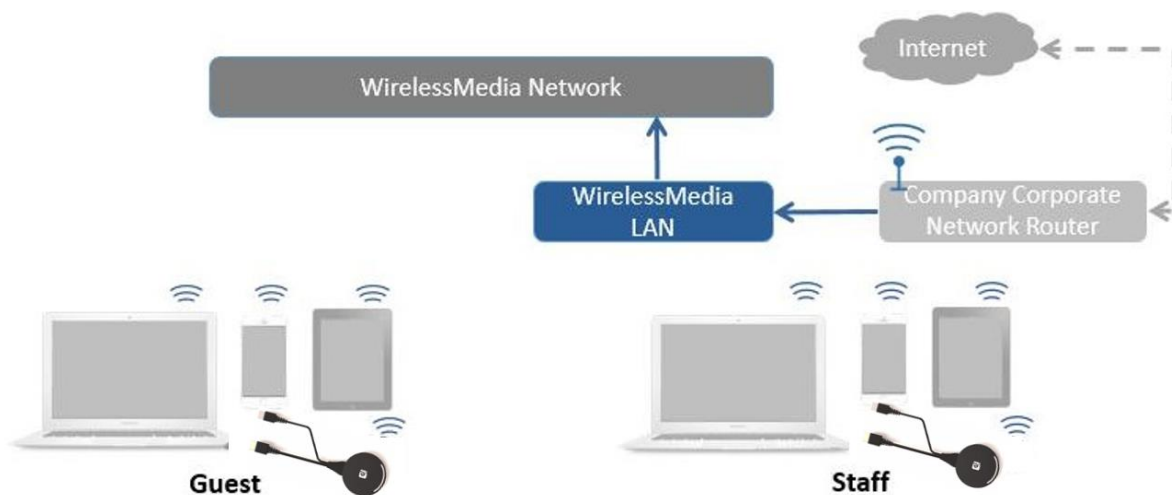

Home	Web UI	Web GUI Setting	Network Settings	Display & Audio	Moderator Control	System Settings	Security Settings	Firmware Upgrade	Other Settings	UCC Device Manager	TECHNICAL DATA
HW	Management & Configuration	PRECAUTIONS	DESCRIPTION & FEATURES	INSTALL & CONNECT	START-UP & OPERATION	FIRMWARE UPDATE	PANEL FUNCTIONS & WIRELESS TRANSMITTERS	TROUBLESHOOTING			
	PACKAGE CONTENTS										

1. Click “Next step” to choose a LAN network which is used for the company staff users and pair the wireless transmitters again into this network.

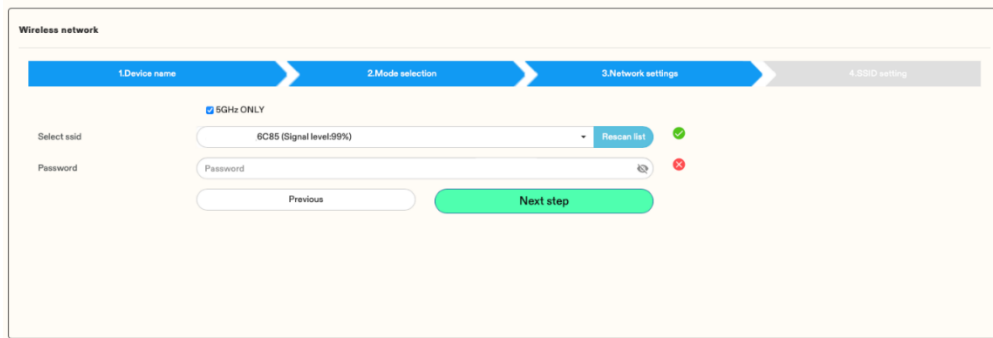

2. Click “Next step” to edit or change GUEST and STAFF network SSID.

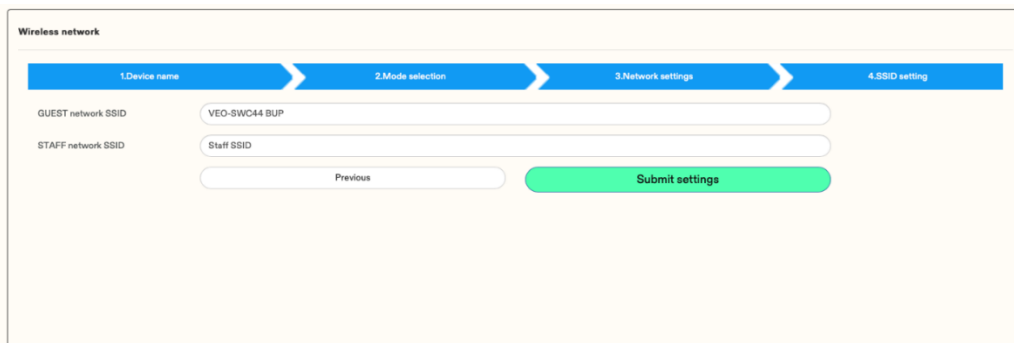

3. WiFi name of Guest and Staff will be displayed on Home Screen after “Submit settings”.
4. After submitting successfully, please pair wireless transmitters again with VEO-SWC44.

Home	Web UI Management & Configuration	Web UI Setting	Network Settings	Display & Audio	Moderator Control	System Settings	Security Settings	Firmware Upgrade	Other Settings	UCC Device Manager	TECHNICAL DATA
HW	PRECAUTIONS	PACKAGE CONTENTS	DESCRIPTION & FEATURES	INSTALL & CONNECT	START-UP & OPERATION	FIRMWARE UPDATE	PANEL FUNCTIONS & WIRELESS TRANSMITTERS	TROUBLESHOOTING			

6.1.2 Ethernet

This section will let the user configure the wired LAN 1 and LAN2 settings.

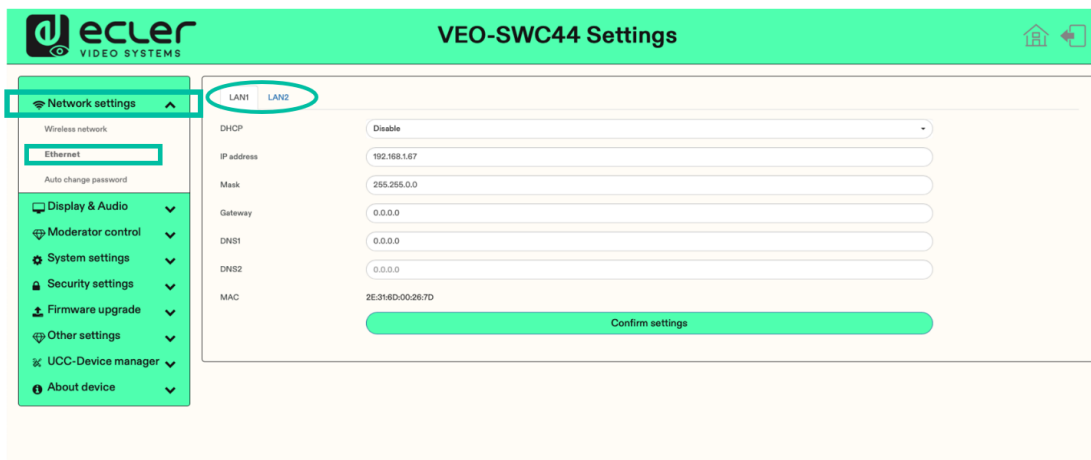

- **DHCP:** this parameter lets the user to enable the automatic assignment of IP address if a DCHP server is present in the network. To configure a fixed IP address, first this parameter should be disabled.
- **Mask:** this parameter lets the user introduce the desired network mask.
- **Gateway:** this parameter lets the user introduce the desired IP gateway.
- **DNS1-2:** this parameter lets the user introduce the desired DNS servers.

6.1.3 Auto Change Password

The password remains unchanged for all participants of the meeting, while at least one wireless transmitter or mobile device is connected to VEO-SWC44 base unit. After the user is disconnected, a configurable timeout will start. User do not need to re-pair the VEO-SWC44TH / VEO-SWC44TU again if the password is changed.

1. Configure to automatically change WiFi password to a random number every period of time.

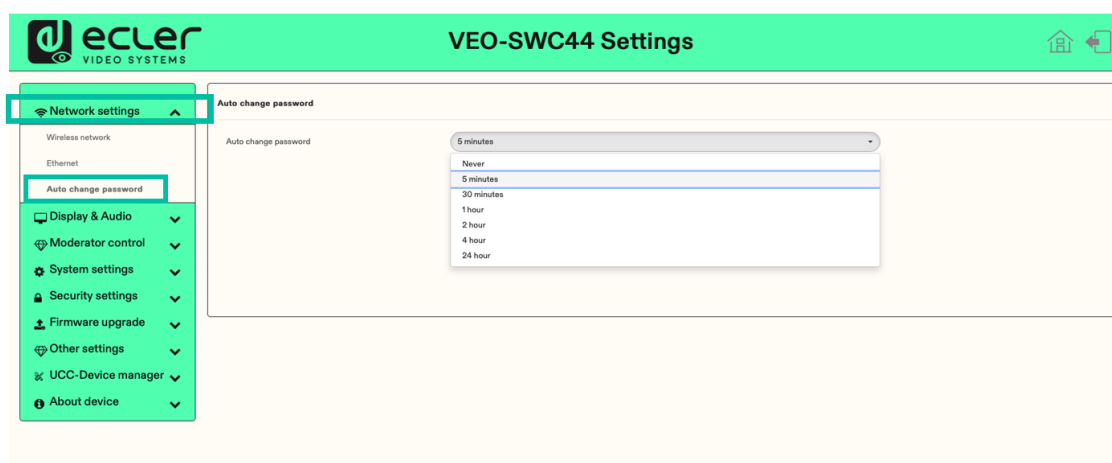

Home	Web UI	Web UI Setting	Network Settings	Display & Audio	Moderator Control	System Settings	Security Settings	Firmware Upgrade	Other Settings	UCC Device Manager	TECHNICAL DATA
HW	Web UI	Management & Configuration	PRECAUTIONS	INSTALL & CONNECT	START-UP & OPERATION	FIRMWARE UPDATE	PANEL FUNCTIONS & WIRELESS TRANSMITTERS	TROUBLESHOOTING			
		PACKAGE CONTENTS	DESCRIPTION & FEATURES								

2. Click to set the configuration:

- **Never:** never change WiFi password. (Even after POWER-OFF condition)
- **5 minutes:** change WiFi password every 5 minutes.
- **30 minutes:** change WiFi password every 30 minutes.
- **1 hour:** change WiFi password every 1 hour.
- **2 hours:** change WiFi password every 2 hours.
- **4 hours:** change WiFi password every 4 hours.
- **24 hours:** change WiFi password every 24 hours.

6.2 Display & Audio

6.2.1 HDMI

6.2.1.1 HDMI Resolution

Select the resolution at HDMI output of base-unit.

Existing HDMI output resolution as below:

- Auto
- 3840x2160@60Hz
- 3840x2160@50Hz
- 3840x2160@30Hz
- 1920x1080@60Hz
- 1920x1080@50Hz
- 1920x1080@30Hz
- 1280x720@60Hz
- 1280x720@50Hz

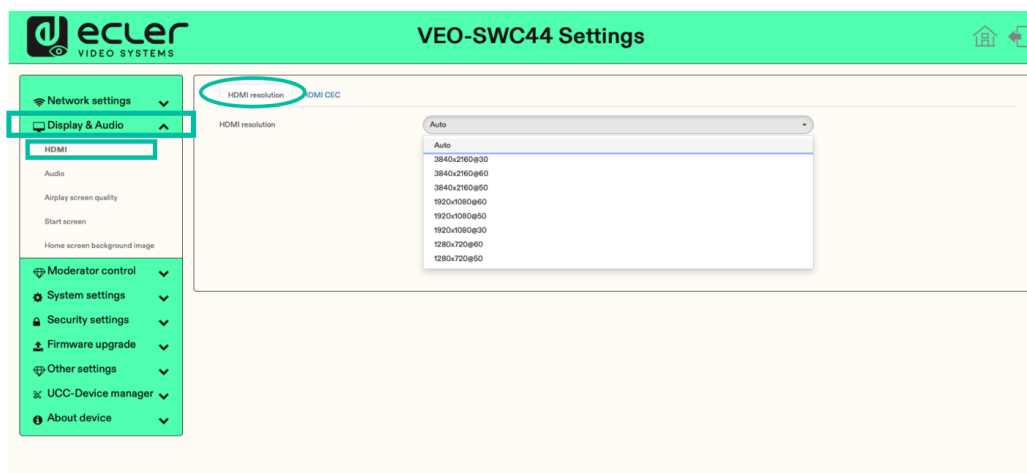

If the display only supports FULL HD, the 4K resolution will not be displayed on the resolution list.

Home	Web UI	Web UI Setting Management & Configuration	Network Settings	Display & Audio	Moderator Control	System Settings	Security Settings	Firmware Upgrade	Other Settings	UCC Device Manager	TECHNICAL DATA
HW	PRECAUTIONS	PACKAGE CONTENTS	DESCRIPTION & FEATURES	INSTALL & CONNECT	START-UP & OPERATION	FIRMWARE UPDATE	PANEL FUNCTIONS & WIRELESS TRANSMITTERS	TROUBLESHOOTING			

6.2.1.2 HDMI CEC

VEO-SWC44 support CEC function if the connected display support CEC function.

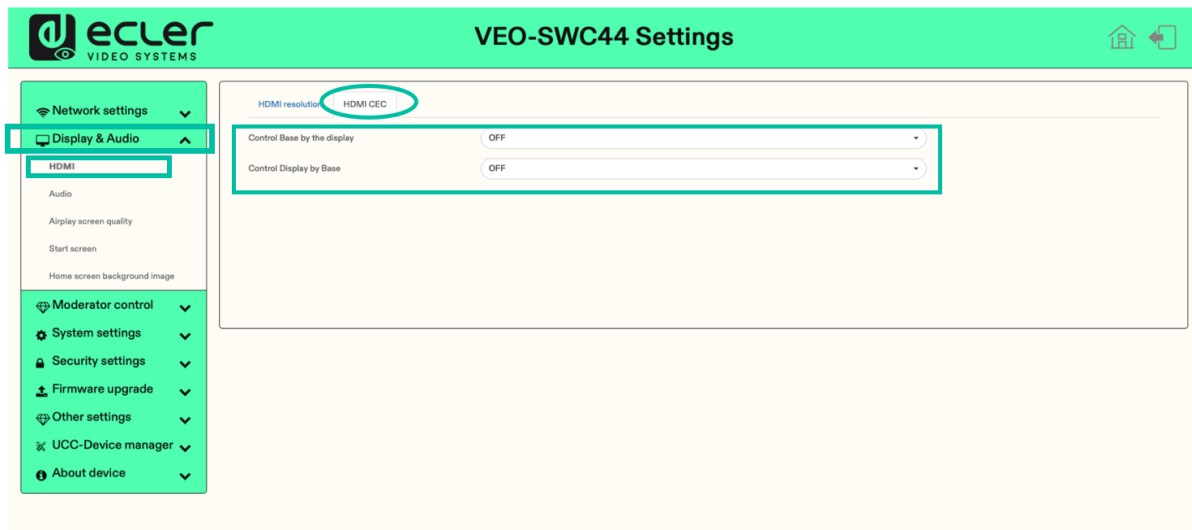

- **Control Base by the display**

With this option, you can choose whether the connected VEO-SWC44 base unit automatically enters standby mode or not as soon as the display is turned off.

- **On:** As soon as the display is turned off, the unit base VEO-SWC44 will also be auto turned off.
- **Off (Default):** The display is turned off but the VEO-SWC44 will not be auto turned off.

- **Control Display by Base**

With this option, you can choose whether the display automatically enters standby mode or not as soon as the connected unit base VEO-SWC44 is turned off.

- **ON (Default):** As soon as the VEO-SWC44 is turned off, the connected display will also auto turn off.
- **OFF:** Display will not automatically turn off when VEO-SWC44 is turned off.

Home	Web UI	Web UI Setting	Network Settings	Display & Audio	Moderator Control	System Settings	Security Settings	Firmware Upgrade	Other Settings	UCC Device Manager	TECHNICAL DATA
HW	Management & Configuration	DESCRIPTION & FEATURES	INSTALL & CONNECT	START-UP & OPERATION	FIRMWARE UPDATE	PANEL FUNCTIONS & WIRELESS TRANSMITTERS	TROUBLESHOOTING	PRECAUTIONS	PACKAGE CONTENTS		

6.2.2 Audio

Allows the user to choose which sound source is routed to audio output.



1. Audio output:

- **Jack:** output only 3.5mm mini-jack audio.
- **HDMI:** output only HDMI audio.
- **Jack&HDMI (Default):** output Jack & HDMI audio.

2. Audio volume: volume can be selected from 0 to 100.

6.2.3 Airplay Screen Quality

Click to select the image quality for the Apple device that is transmitting through AirPlay.

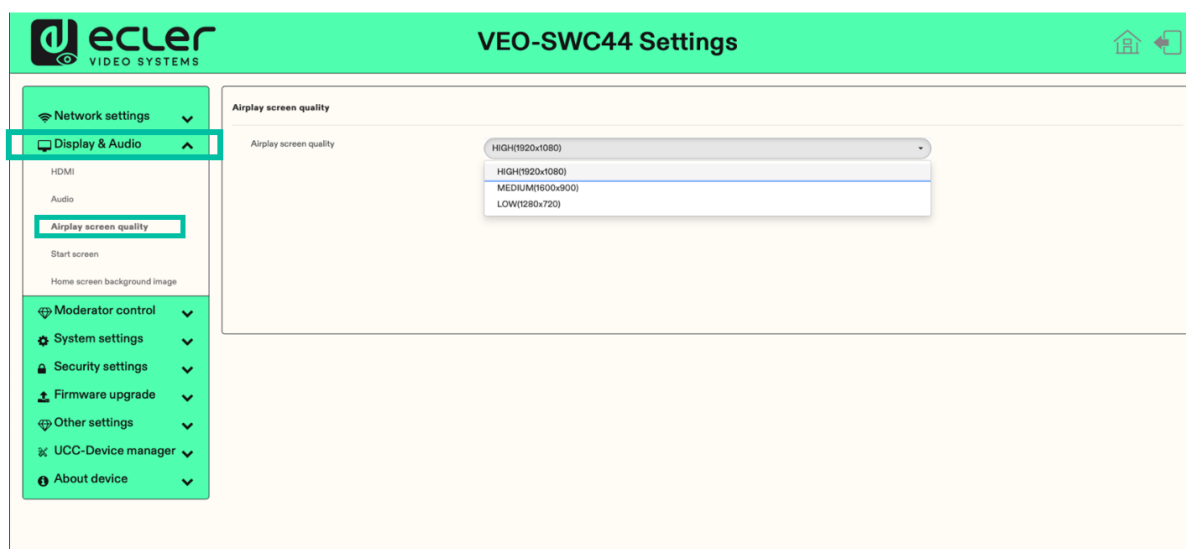

Home	Web UI
HW	Web UI
PRECAUTIONS	Web UI Setting Management & Configuration
PACKAGE CONTENTS	Network Settings
DESCRIPTION & FEATURES	Display & Audio
INSTALL & CONNECT	Moderator Control
START-UP & OPERATION	System Settings
FIRMWARE UPDATE	Security Settings
PANEL FUNCTIONS & WIRELESS TRANSMITTERS	Firmware Upgrade
TROUBLESHOOTING	Other Settings
TECHNICAL DATA	UCC Device Manager

6.2.4 Start Screen



- **Show the base device name and password when mirroring:** Name (ID) and WiFi password can be shown or hidden at top status-line of main screen.
- **Show PCs username when mirroring.**

6.2.5 Home Screen Background Image

When powering VEO-SWC44, the Home Screen will be displayed. **User can change background image of Home Screen.**

Select the image (jpg, bmp, png, gif with resolution 1920x1080 p.) from suitable directory and **activate box for selection**. Return to Standard Home Screen is possible every time.

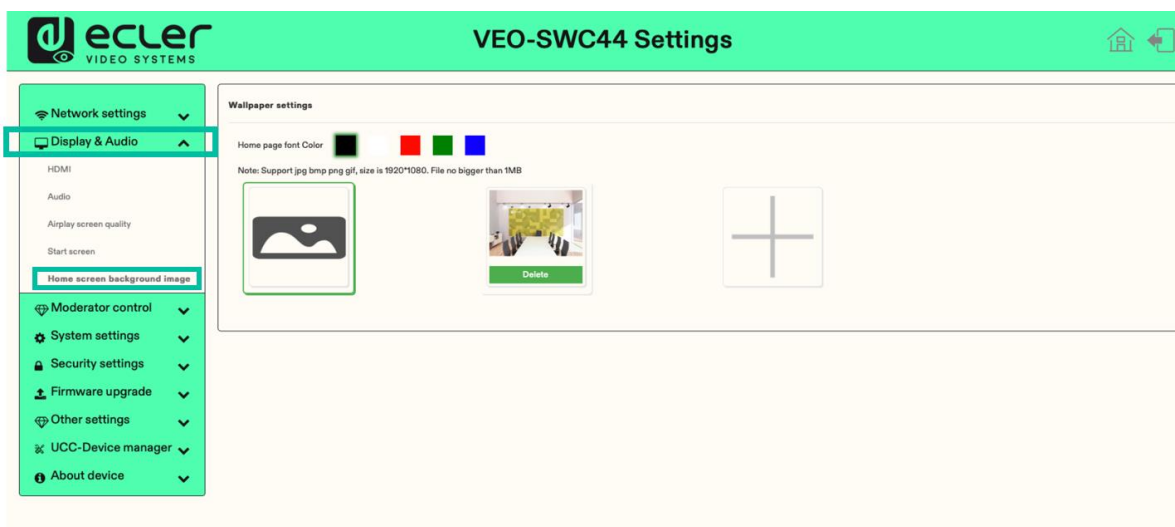

Home	Web UI	Web GUI Setting	Network Settings	Display & Audio	Moderator Control	System Settings	Security Settings	Firmware Upgrade	Other Settings	UCC Device Manager	TECHNICAL DATA
HW	Management & Configuration	PRECAUTIONS	PACKAGE CONTENTS	DESCRIPTION & FEATURES	INSTALL & CONNECT	START-UP & OPERATION	FIRMWARE UPDATE	PANEL FUNCTIONS & WIRELESS TRANSMITTERS	TROUBLESHOOTING		

6.3 Moderator Control

The user can **enable or disable moderator control and preview on moderator side bar.**

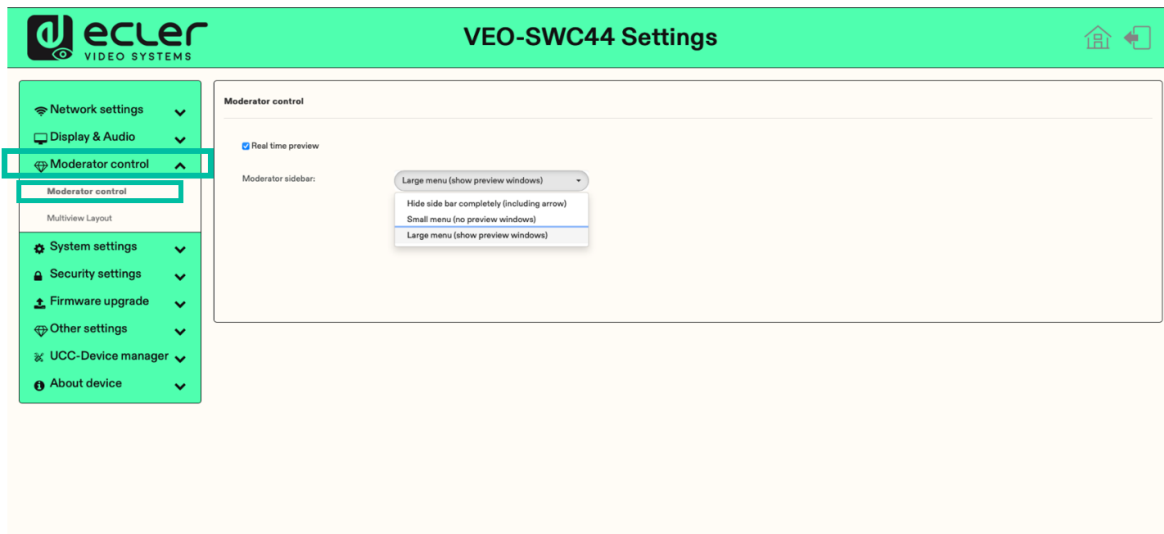

6.3.1 Moderator Layout

This section **allows for various fixed window layout presets to show participants in the main screen. Up to four simultaneously.**

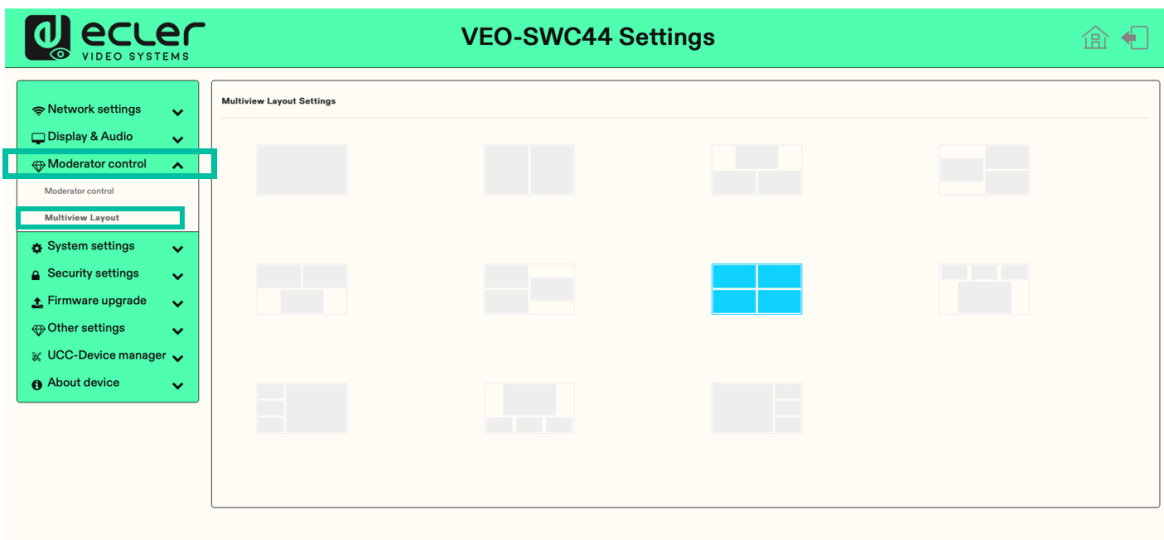

Home	Web UI	Web GUI Setting	Network	Display & Audio	Moderator Control	System Settings	Security Settings	Firmware Upgrade	Other Settings	UCC Device Manager
HW	Management & Configuration	DESCRIPTION & FEATURES	INSTALL & CONNECT	START-UP & OPERATION	FIRMWARE UPDATE	PANEL FUNCTIONS & WIRELESS TRANSMITTERS	TROUBLESHOOTING	TECHNICAL DATA	PRECAUTIONS	PACKAGE CONTENTS

6.4 System Settings

6.4.1 Buttons

This section allows to manage VEO-SWC44TH and VEO-SWC44TU.

- **Connected:** Display Device name, MAC Address, Serial Number, Device Version, Device Status, Last Action, Item Operate.



- **Paired:** Displays properties of connected VEO-SWC44TH / VEO-SWC44TU and can be managed from this page.

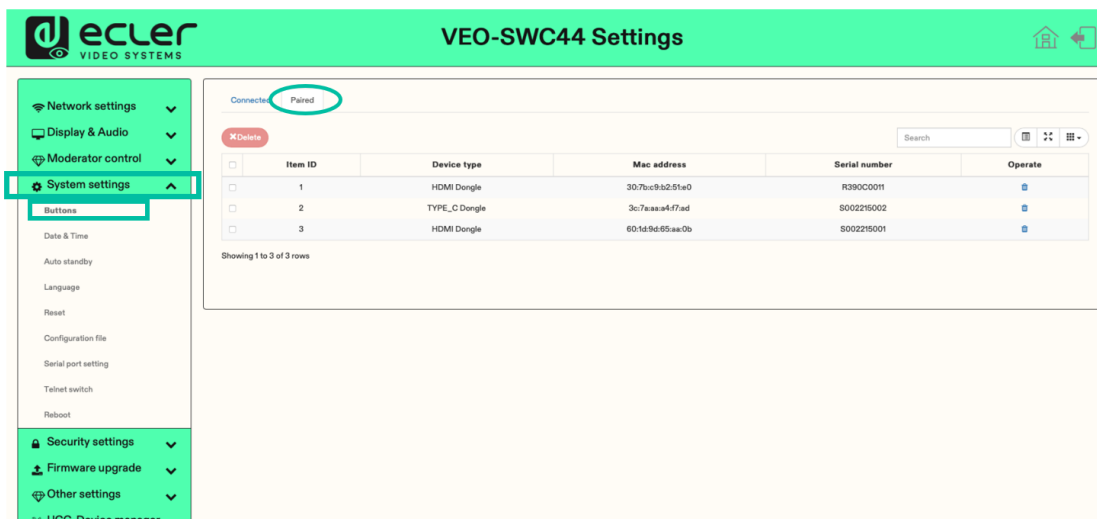

6.4.2 Date & Time

Includes Automatic date & time, Set date, Set time, Select time zone.

- **Automatic date & time:** Check to use a NTP time server to provide time as system time.
- **Set date:** Click in the input field to fill out the appropriate date.

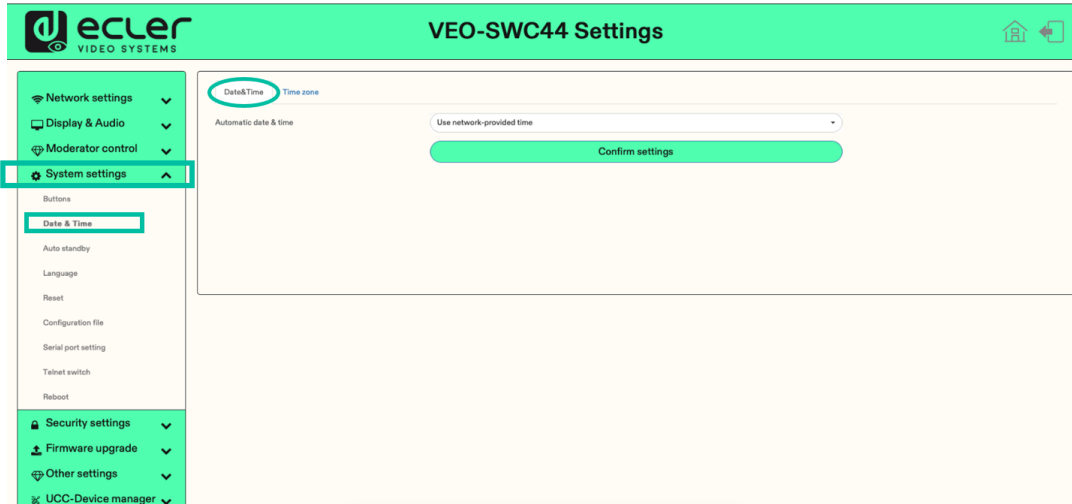

- **Select time zone:** Click in the Time Zone tab to select the appropriate time zone.

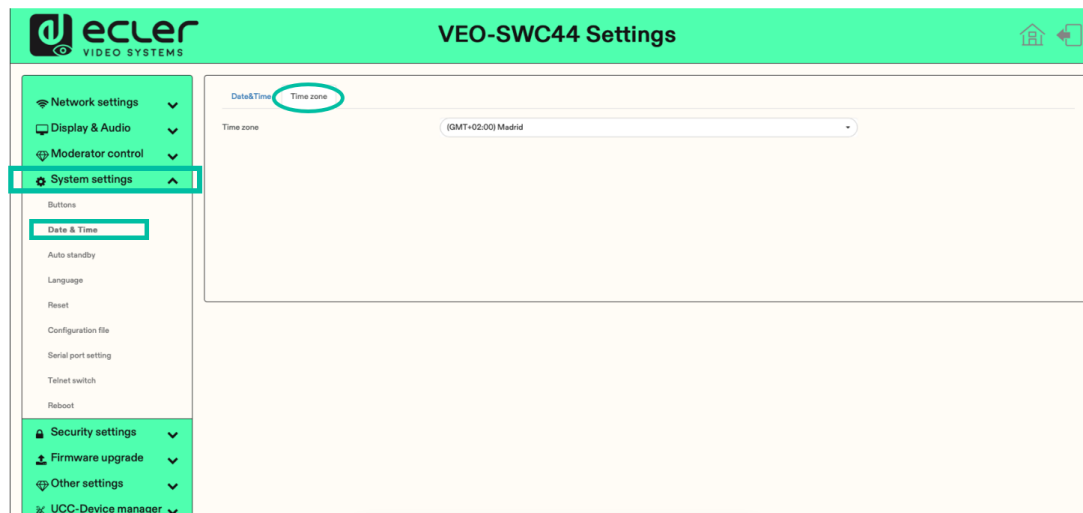

Home	Web UI Settings	Web UI Settings	Network Settings	Display & Audio	Moderator Control	System Settings	Security Settings	Firmware Upgrade	Other Settings	UCC Device Manager	TECHNICAL DATA
HW	Management & Configuration	PRECAUTIONS	DESCRIPTION & FEATURES	INSTALL & CONNECT	START-UP & OPERATION	FIRMWARE UPDATE	PANEL FUNCTIONS & WIRELESS TRANSMITTERS	TROUBLESHOOTING			
	PACKAGE CONTENTS										

6.4.3 Auto Standby

If the **Auto Standby** mode is **activated**, VEO-SWC44 will **automatically switch to power saving mode**, a selectable time after the last wireless transmitter was plugged out, or WiFi of a mobile unit was disconnected, or there is no operation at the system. **Time is selectable from Never, up to 30 minutes**. In Standby green LED in top of surface of VEO-SWC44 is **flashing** and **HDMI-output is switched off**.



- When a VEO-SWC44TH / VEO-SWC44TU is plugged in and connected, or a mobile device is connected, Standby is deactivated.
- Movement of mouse at USB-input at VEO-SWC44 base unit deactivates standby mode also.

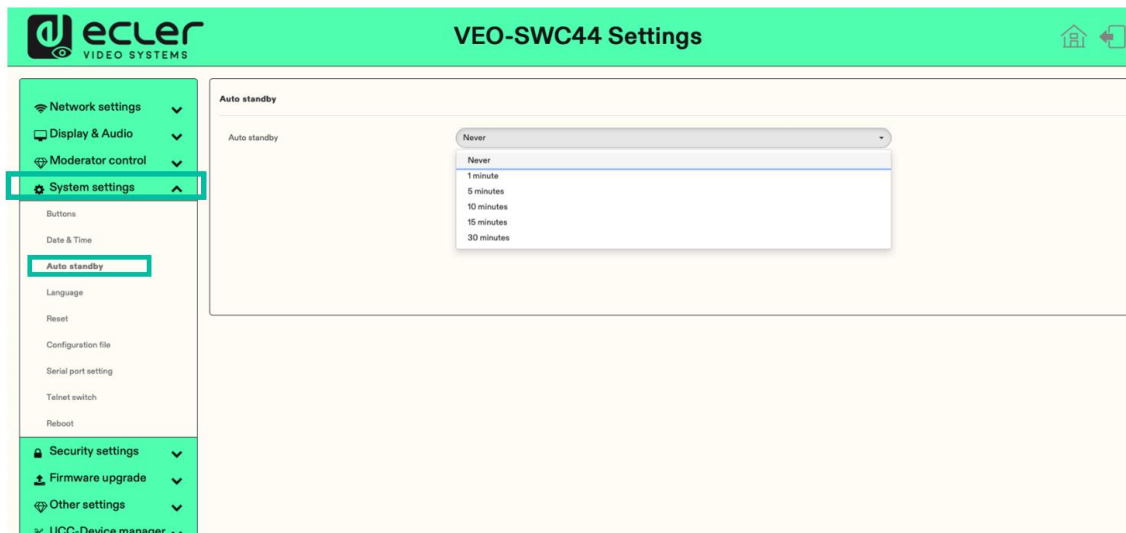

6.4.4 Language

This parameter allows the user to **select the display language**.

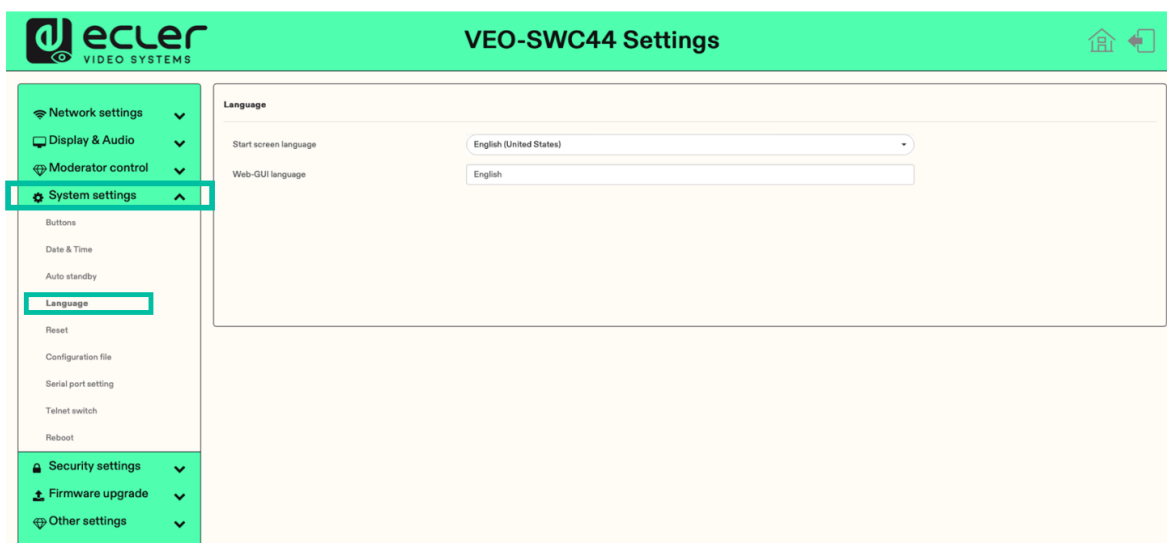

Home	Web GUI	Web GUI Setting	Network Settings	Display & Audio	Moderator Control	System Settings	Security Settings	Firmware Upgrade	Other Settings	UCC Device Manager	TECHNICAL DATA
HW	PRECAUTIONS	PACKAGE CONTENTS	DESCRIPTION & FEATURES	INSTALL & CONNECT	START-UP & OPERATION	FIRMWARE UPDATE	PANEL FUNCTIONS & WIRELESS TRANSMITTERS	TROUBLESHOOTING			

6.4.5 Reset

This parameter allows the user to **perform a Factory reset** to restore the unit.

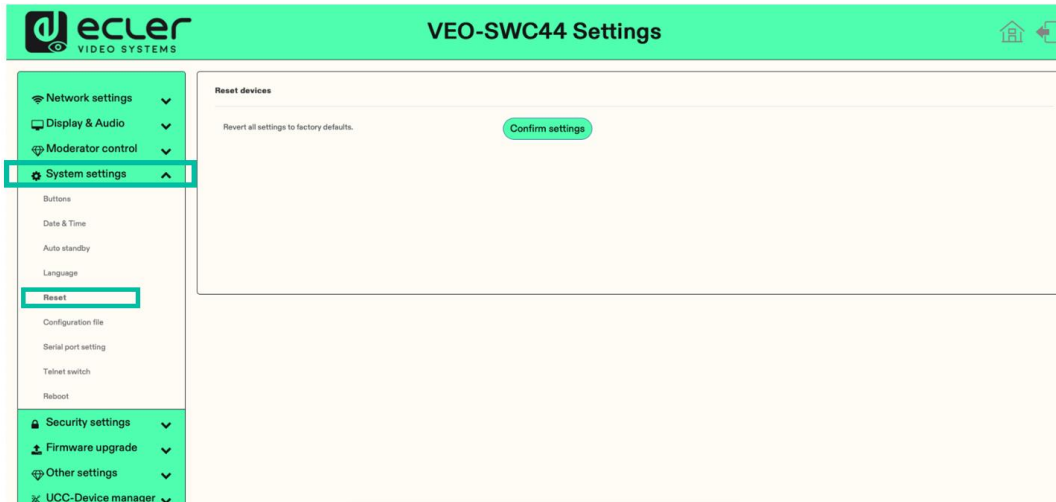

6.4.6 Configuration File

Configuration File is a **preset which can be downloaded and will save all the configuration parameters set** so they can be loaded to additional devices.

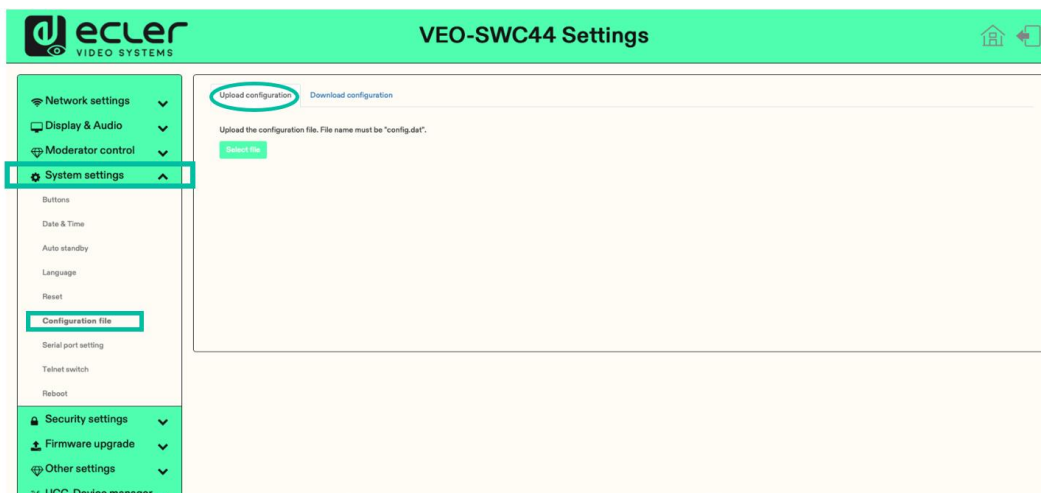
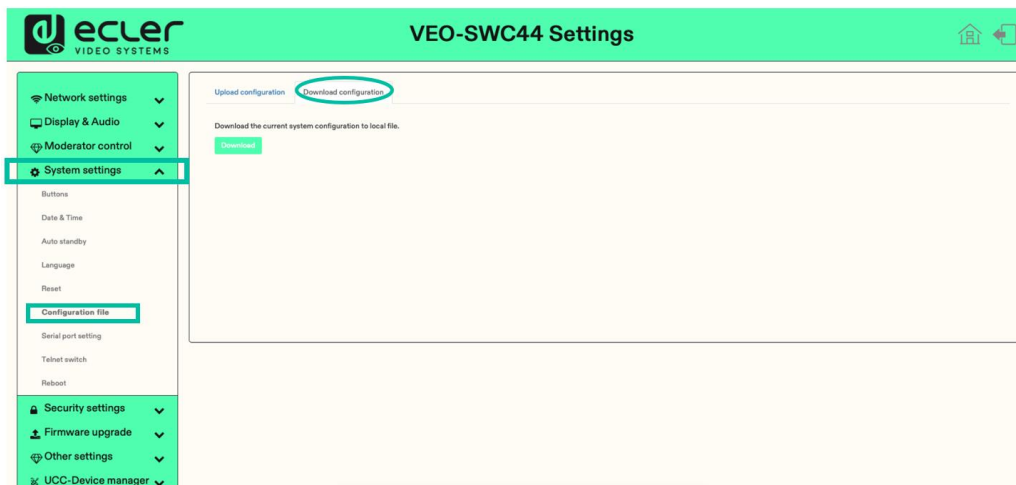

Home	Web UI	Web UI Setting	Network Settings	Display & Audio	Moderator Control	START-UP & OPERATION	FIRMWARE UPDATE	Security Settings	Firmware Upgrade	Other Settings	UCC Device Manager	TECHNICAL DATA
HW	Management & Configuration	PRECAUTIONS	PACKAGE CONTENTS	DESCRIPTION & FEATURES	INSTALL & CONNECT	WIRELESS TRANSMITTERS	TROUBLESHOOTING					

6.4.7 Series Port Setting

This parameter allows the user to **configure telnet command and RS-232 commands to control VEO-SWC44.**

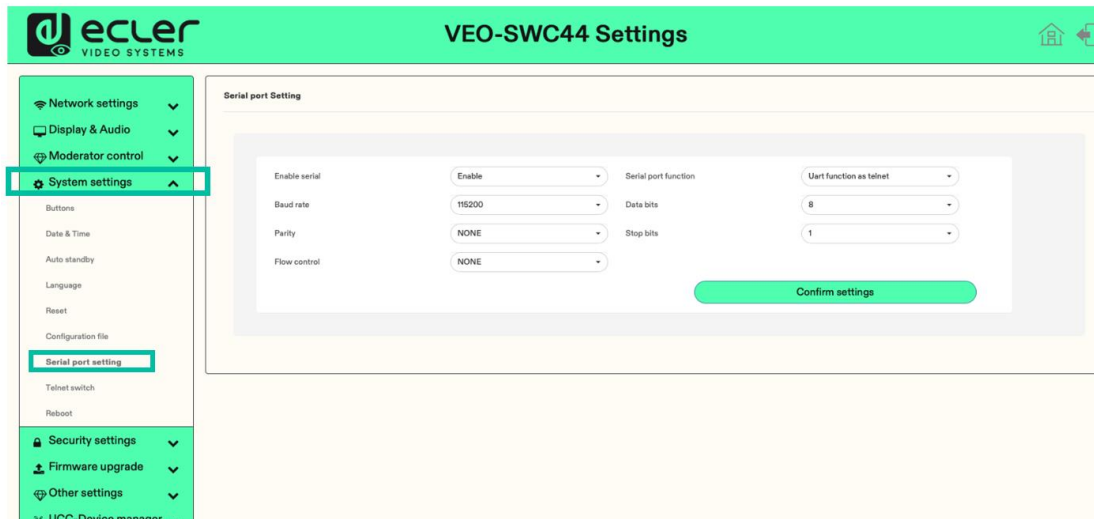

6.4.7.1 Control commands

VEO-SWC44 can be remotely controlled over RS-232 or Telnet communications protocol.

- For **RS-232 serial communication**, enter the parameters you have selected on the Series Port Setting-screen as mentioned above.
- For **Telnet communication over TCP commands**, enter the current VEO-SWC44 base unit IP address and Port: 23.

!

- For **commands with more than one word**, a **blank space is required** between each word.
- Commands **are not cap sensitive**.
- For **EclerNet Manager integration**, it is important to **type commands following the next syntax example**: `[tcp]<IP address>|port|\d1<command code>\r\d3|`

Command Code	Description	Command Example
home	Goes back to Home Screen.	
wifi on	Turns VEO-SWC44 WiFi hotspot ON.	
wifi off	Turns VEO-SWC44 WiFi hotspot OFF.	
wifi channel	Sets VEO-SWC44 WiFi hotspot channel.	
wifi ssid xxx	Sets VEO-SWC44 WiFi hotspot SSID name. xxx is the name of the SSID.	wifi ssid MeetingRoom

Home	Web UI Setting	Network Settings	Display & Audio	Moderator Control	System Settings	Security Settings	Firmware Upgrade	Other Settings	UCC Device Manager
HW	Management & Configuration	DESCRIPTION & FEATURES	INSTALL & CONNECT	START-UP & OPERATION	FIRMWARE UPDATE	PANEL FUNCTIONS & WIRELESS TRANSMITTERS	TROUBLESHOOTING	TECHNICAL DATA	
PRECAUTIONS	PACKAGE CONTENTS								

wifi pass xxx	Sets a specific VEO-SWC44 WiFi hotspot SSID password. xxx is the name of the SSID. 8 digits password.	wifi pass 01234567
wifi list	Lists all devices connected to the VEO-SWC44 WiFi hotspot.	
wifi amount	Shows how many devices are connected to the VEO-SWC44 WiFi hotspot.	
mute on	Turns on mute on VEO-SWC44 line out.	
mute off	Turns off mute on VEO-SWC44 line out.	
mute ?	Shows the current mute status on the VEO-SWC44 line out.	
standby wakeup	Wakes up VEO-SWC44.	
standby set xxx	<p>PARAMETERS DESCRIPTION</p> <p>Where “xxx” can be the following:</p> <ul style="list-style-type: none"> • off: Turns the standby timeout of the VEO-SWC44 off. • timeout: Sets the available timeout time figure (in minutes) before VEO-SWC44 is turned off. Available options are 1,5,10,15,30. 	<ul style="list-style-type: none"> • standby set off • standby set 5
button lc	Lists the wireless transmitters and VEOShare devices connected details.	
button lcd	Lists the wireless transmitters and VEOShare devices disconnected details.	
button ls	Lists the wireless transmitters and VEOShare devices that are currently sharing screen with VEO-SWC44.	
button share xxx	Starts screen sharing for the selected wireless transmitter or VEOShare device. xxx is the chosen device’s mac address which can be found on the web settings section referred in Buttons chapter .	button share 307bc9b251e0
button stop xxx	Stops screen sharing for the selected wireless transmitter or VEOShare device. xxx is the chosen device’s mac address which can be found on the web settings section referred in Buttons chapter .	button stop 307bc9b251e0
statusbar show	Shows the status bar on the Home screen.	

Home	Web UI Setting	Network Settings	Display & Audio	Moderator Control	System Settings	Security Settings	Firmware Upgrade	Other Settings	UCC Device Manager	TECHNICAL DATA
HW	Web UI Setting	Network Settings	Display & Audio	Moderator Control	System Settings	Security Settings	Firmware Upgrade	Other Settings	UCC Device Manager	TECHNICAL DATA
PRECAUTIONS	PACKAGE CONTENTS	DESCRIPTION & FEATURES	INSTALL & CONNECT	START-UP & OPERATION	FIRMWARE UPDATE	PANEL FUNCTIONS & WIRELESS TRANSMITTERS	TROUBLESHOOTING			

statusbar hide	Hides the status bar on the Home screen.	
pass refresh	Changes the current password key available to connect to VEO-SWC44 shown in the Home Screen.	
pass ?	Shows the current password key available to connect to VEO-SWC44 shown in the Home Screen.	
security x	Sets the current security profile selected for the VEO-SWC44. Available options are 1,2,3,4.	security 3
security ?	Shows the current security profile selected for the VEO-SWC44.	
pair remove xxxx	Removes the chosen wireless transmitter. xxx is the chosen device's mac address which can be found on the web settings section referred in Buttons chapter .	pair remove 307bc9b251e0
pair ?	Shows the wireless transmitter and VEOShare devices paired details.	
volume xx	Sets the chosen volume level on the VEO-SWC44 line out. Available options 0 -100.	
volume ?	Shows the current volume status on the VEO-SWC44 line out.	

6.4.8 Telnet Switch

This section allows the user to **switch on or off the telnet function**.

6.4.9 Reboot

This section allows the user to **execute a random reboot and schedule a rebooting routine for a given week**.



Home	Web UI Setting	Network Settings	Display & Audio	Moderator Control	System Settings	Security Settings	Firmware Upgrade	Other Settings	UCC Device Manager	TECHNICAL DATA
HW	PRECAUTIONS	PACKAGE CONTENTS	DESCRIPTION & FEATURES	INSTALL & CONNECT	START-UP & OPERATION	FIRMWARE UPDATE	PANEL FUNCTIONS & WIRELESS TRANSMITTERS	TROUBLESHOOTING		

6.5 Security Settings

6.5.1 Security Level

Based on user requirements, **three different security levels can be set** to satisfy different security requirements.

Click on the corresponding entry in the menu to adjust the respective security features.
The default setting is level 1.

- **Level 1: normal safety;** keeps the security in normal and daily usage for any organization, such like classroom, regular meeting room etc.
- **Level 2: higher security;** provides increased security for companies, organizations, government agencies, etc., through powerful encryption of audio and video data; other security features include limiting the transmission of "AirPlay" by introducing a password.
- **Level 3:** is used for **strict security** requirements of companies, organizations, authorities, banks.

This level contains all "Level 2" security measures and in addition, all mobile applications as well as the web settings GUI will be blocked. In addition, the downgrade of the firmware will not be possible.

The security level will be displayed in the Home Screen clicking on the icon

#	Security Item	level 1	level 2	level 3	Customize
1	Dynamic code:Change code every	<input checked="" type="checkbox"/>	<input checked="" type="checkbox"/>	<input checked="" type="checkbox"/>	<input checked="" type="checkbox"/>
2	Encryption of Data:Proprietary	<input checked="" type="checkbox"/>	<input checked="" type="checkbox"/>	<input checked="" type="checkbox"/>	<input checked="" type="checkbox"/>
3	Changing the code deletes all temporary data from base unit	<input checked="" type="checkbox"/>	<input checked="" type="checkbox"/>	<input checked="" type="checkbox"/>	<input checked="" type="checkbox"/>
4	"Airplay" PIN code	<input type="checkbox"/>	<input checked="" type="checkbox"/>	<input checked="" type="checkbox"/>	<input checked="" type="checkbox"/>
5	Telnet password	<input type="checkbox"/>	<input checked="" type="checkbox"/>	<input checked="" type="checkbox"/>	<input type="checkbox"/>
6	Encryption of Data: AES-256 Bit + RSA-1024Bit	<input type="checkbox"/>	<input checked="" type="checkbox"/>	<input checked="" type="checkbox"/>	<input type="checkbox"/>
7	Password changing deletes and removes the data of the base unit	<input type="checkbox"/>	<input checked="" type="checkbox"/>	<input checked="" type="checkbox"/>	<input type="checkbox"/>
8	"Miracast" PIN code	<input type="checkbox"/>	<input checked="" type="checkbox"/>	<input checked="" type="checkbox"/>	<input checked="" type="checkbox"/>
9	Disable the android APK	<input type="checkbox"/>	<input type="checkbox"/>	<input checked="" type="checkbox"/>	<input type="checkbox"/>
10	Disable "Airplay"	<input type="checkbox"/>	<input type="checkbox"/>	<input checked="" type="checkbox"/>	<input type="checkbox"/>
11	Disable "Firmware Degrade"	<input type="checkbox"/>	<input type="checkbox"/>	<input checked="" type="checkbox"/>	<input type="checkbox"/>
12	Disable Miracast	<input type="checkbox"/>	<input type="checkbox"/>	<input checked="" type="checkbox"/>	<input checked="" type="checkbox"/>
13	Disable "Chromecast"	<input type="checkbox"/>	<input type="checkbox"/>	<input checked="" type="checkbox"/>	<input checked="" type="checkbox"/>

6.5.2 Login Password

This section allows the user to change password to entering web settings GUI. Default password is “admin”.

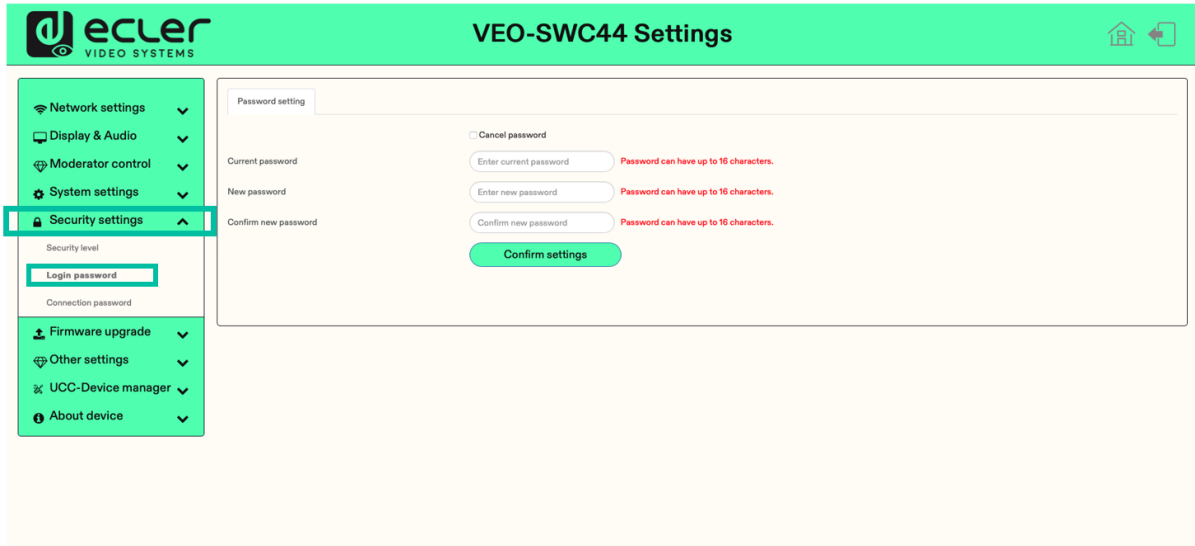

6.5.3 Connection Password

Two type of password format can be chosen to be displayed on Home Screen.

- 4-digits password, beginning with 0000
- 8-digits password



Home	Web GUI	Web GUI Setting Management & Configuration	Network Settings	Display & Audio	Moderator Control	System Settings	Security Settings	Firmware Upgrade	Other Settings	UCC Device Manager	TECHNICAL DATA
HW	PRECAUTIONS	PACKAGE CONTENTS	DESCRIPTION & FEATURES	INSTALL & CONNECT	START-UP & OPERATION	FIRMWARE UPDATE	PANEL FUNCTIONS & WIRELESS TRANSMITTERS	TROUBLESHOOTING			

6.6 Firmware Upgrade

6.6.1 Firmware Update

This section allows the user to **upload local updating files to upgrade VEO-SWC44.**

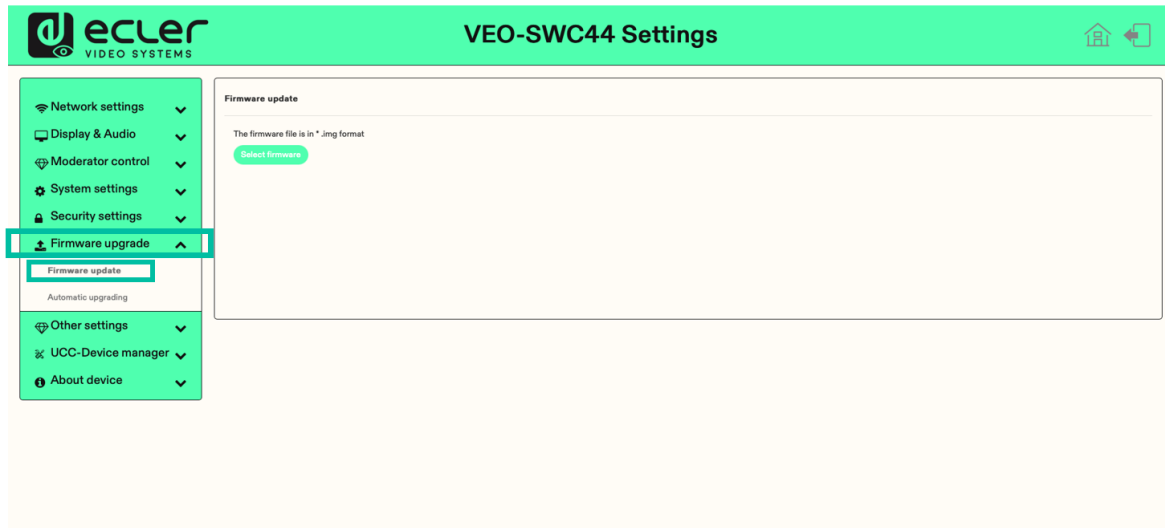

6.6.2 Automatic Upgrading

This section allows to **choose upgrading from OTA via Internet or from local files.**

6.7 Other Settings

6.7.1 Autocreate Launcher

Determines, when **using a USB memory at one USB-port of Base-unit**, the **Launcher program VEOShare will be copied automatically on USB memory.** Enable or disable this option according to your preferences.

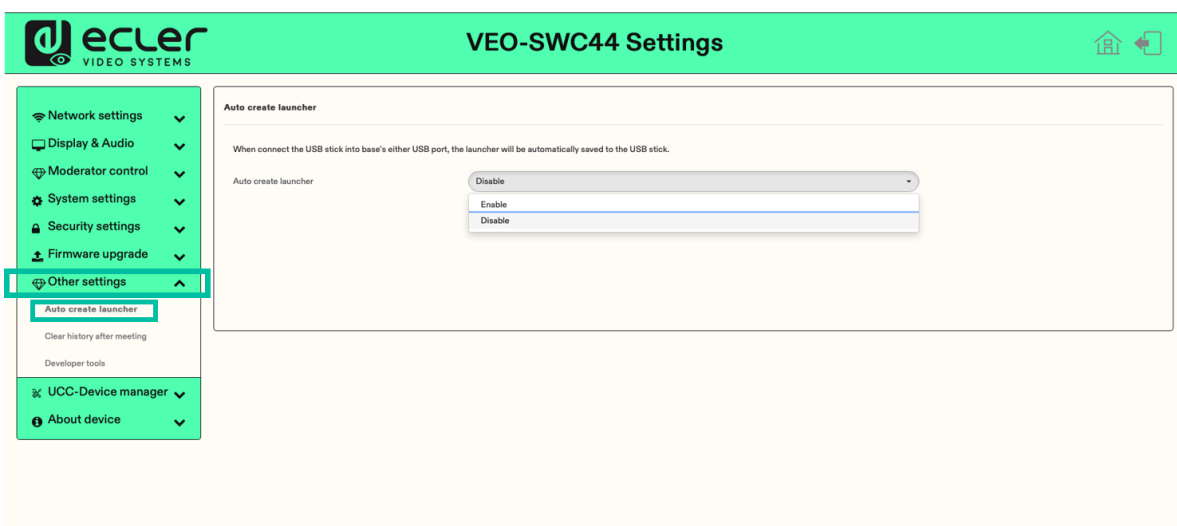

Home	Web UI	Web GUI Setting	Network Settings	Display & Audio	Moderator Control	System Settings	Security Settings	Firmware Upgrade	Other Settings	UCC Device Manager	TECHNICAL DATA
HW	Management & Configuration	PRECAUTIONS	PACKAGE CONTENTS	DESCRIPTION & FEATURES	INSTALL & CONNECT	START-UP & OPERATION	FIRMWARE UPDATE	PANEL FUNCTIONS & WIRELESS TRANSMITTERS	TROUBLESHOOTING		

6.7.2 Clear History After Meeting

Pictures, videos, music of mobile units will be stored in memory of Base-unit. This memory can optionally be erased, at the end of a meeting, when the wireless transmitter is pulled from the Laptop / PC.

Settings are:

- **Decide by User:** a dialog appears when wireless transmitter is pulled.
- **Never:** storage space is automatically erased when memory is filled for 90%
- **Always:** memory is automatically deleted.

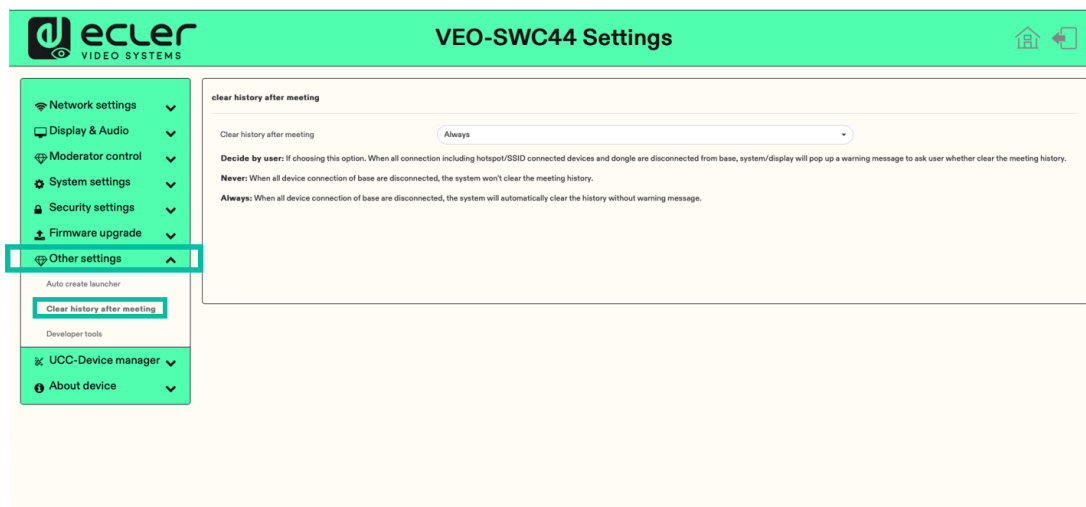

6.8 UCC Device Manager

This section allows the user to select and monitoring UVC and UAC devices connected to the VEO-SWC44 base unit.

6.8.1 USB Camera

This section allows the user to select and see a preview of the current USB video devices.

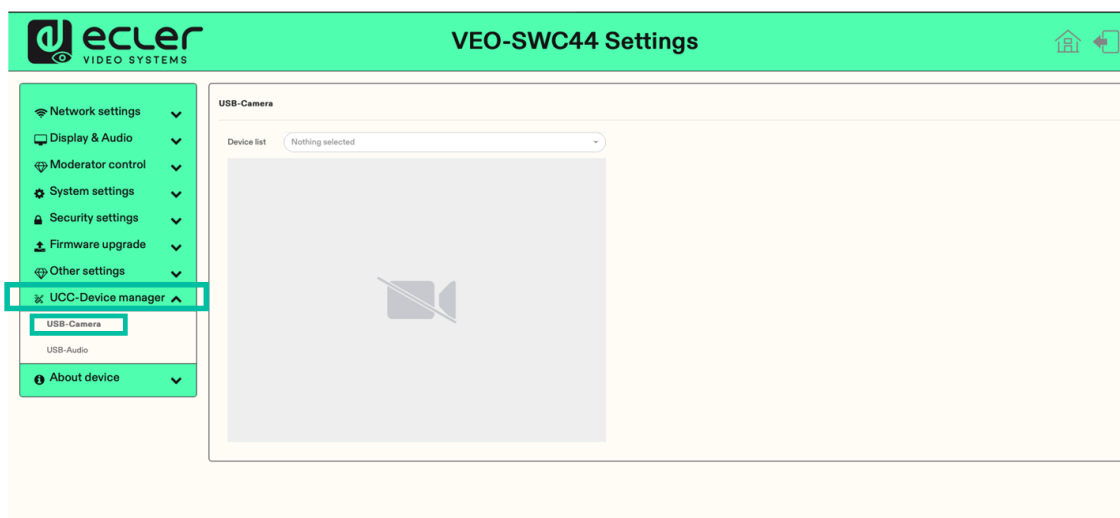

Home	Web UI	Web UI Setting	Network	Display & Audio	Moderator Control	System Settings	Security Settings	Firmware Upgrade	Other Settings	UCC Device Manager	TECHNICAL DATA
HW	Management & Configuration	PRECAUTIONS	DESCRIPTION & FEATURES	INSTALL & CONNECT	START-UP & OPERATION	FIRMWARE UPDATE	PANEL FUNCTIONS & WIRELESS TRANSMITTERS	TROUBLESHOOTING			
	PACKAGE CONTENTS										

6.8.2 USB Audio

Allows the user to **select and see a preview of the current USB audio devices.**

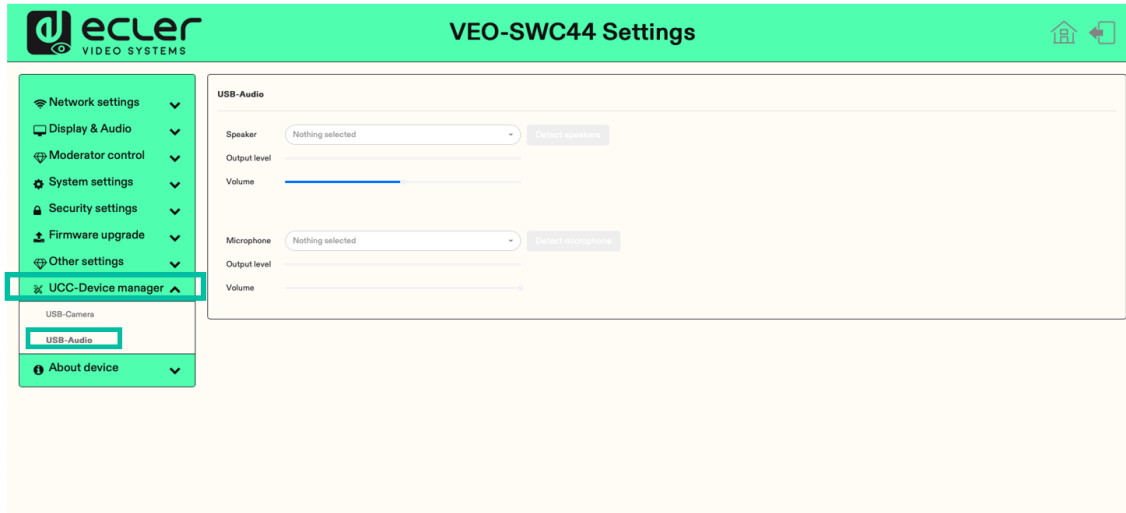

Home	Web UI	WebGUI Setting Management & Configuration	Network Settings	Display & Audio	Moderator Control	System Settings	Security Settings	Firmware Upgrade	Other Settings	UCC Device Manager	TECHNICAL DATA
HW	PRECAUTIONS	PACKAGE CONTENTS	DESCRIPTION & FEATURES	INSTALL & CONNECT	START-UP & OPERATION	FIRMWARE UPDATE	PANEL FUNCTIONS & WIRELESS TRANSMITTERS	TROUBLESHOOTING			

7. FIRMWARE UPDATE

There are **three different elements** that can require firmware updating:

- Base unit:
 - VEO-SWC44
- Wireless transmitters:
 - VEO-SWC44TH
 - VEO-SWC44TU

! All software is stored in VEO-SWC44 base unit and later transferred to the rest of the elements. After updating the VEO-SWC44 base unit, it is necessary to check whether the other parts need to be updated as well.

7.1 Upgrading Firmware version of VEO-SWC44

- External USB storage drive:
 1. Copy the updating file “update.img” to the root directory of the USB drive.
 2. Connect the USB drive to either USB 2.0 front port of VEO-SWC44 base unit.
 3. VEO-SWC44 recognizes the “update.img”-file at the plugged-in USB stick automatically and starts the “Full Update” procedure. USB stick can be plugged out within 10 seconds to stop the update.

! Do not disconnect power during upgrading progress. Otherwise, the unit firmware will be corrupted.

4. The upgrading progress displays as shown, and the VEO-SWC44 will reboot automatically after completing the updating.

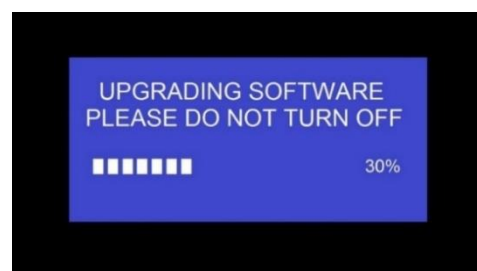

! During the update, screen can be temporary dark.

! If the progress bar stops at 1%, use another USB stick, since this one may be defective.

5. The display device shows the Home Screen after normal boot of the device, you can disconnect USB stick.
6. Perform “Factory Reset” when the firmware update is completed.

Home	Web 5	WebGUI Setting Management & Configuration	Network Settings	Display & Audio	Moderator Control	System Settings	Security Settings	Firmware Upgrade	Other Settings	UCC Device Manager	TECHNICAL DATA
HW	PRECAUTIONS	PACKAGE CONTENTS	DESCRIPTION & FEATURES	INSTALL & CONNECT	START-UP & OPERATION	FIRMWARE UPDATE	PANEL FUNCTIONS & WIRELESS TRANSMITTERS	TROUBLESHOOTING			

- **Web settings:**

1. Browse to “**Firmware update**” section on Web Settings.



2. Select a “**update.img**” file.
3. The **upgrading progress displays** as shown below, and the VEO-SWC44 will reboot automatically after completing the updating.

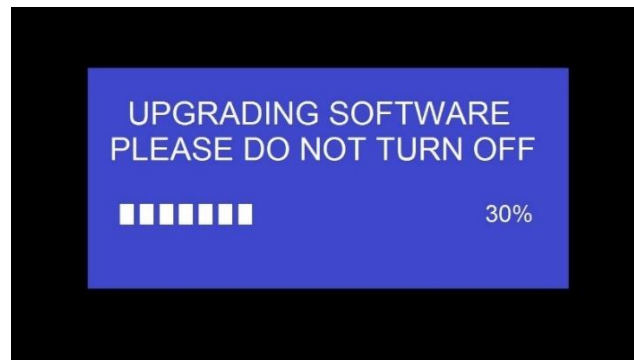

4. The **display device shows the Home Screen** after normal boot of the device,
5. Perform “**Factory Reset**” when the firmware update is completed.

Home	Web UI Setting	Network Settings	Display & Audio	Moderator Control	System Settings	Security Settings	Firmware Upgrade	Other Settings	UCC Device Manager
HW	Web UI Setting Management & Configuration	DESCRIPTION & FEATURES	INSTALL & CONNECT	START-UP & OPERATION	FIRMWARE UPDATE	PANEL FUNCTIONS & WIRELESS TRANSMITTERS	TROUBLESHOOTING	TECHNICAL DATA	
	PRECAUTIONS	PACKAGE CONTENTS							

7.2 Upgrading Firmware version of VEO-SWC44TH / VEO-SWC44TU

1. **Plug the VEO-SWC44TH / VEO-SWC44TU** to the according USB front port of VEO-SWC44 to be updated. It will **automatically display up a message to indicate if** the installed firmware of wireless transmitter is older and **needs to be upgraded**.

2. The **upgrading progress starts automatically** with the progress bar.

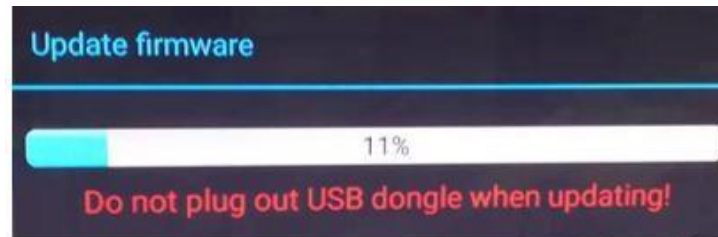

3. “Pairing” to the VEO-SWC44 base unit is **done automatically** afterwards.



4. **Upgrading progress is finished**. Plug out the wireless transmitter (VEO-SWC44TH / VEO-SWC44TU) and **it is now ready to use**.

8. PANEL FUNCTIONS and WIRELESS TRANSMITTERS

8.1 Front Panel

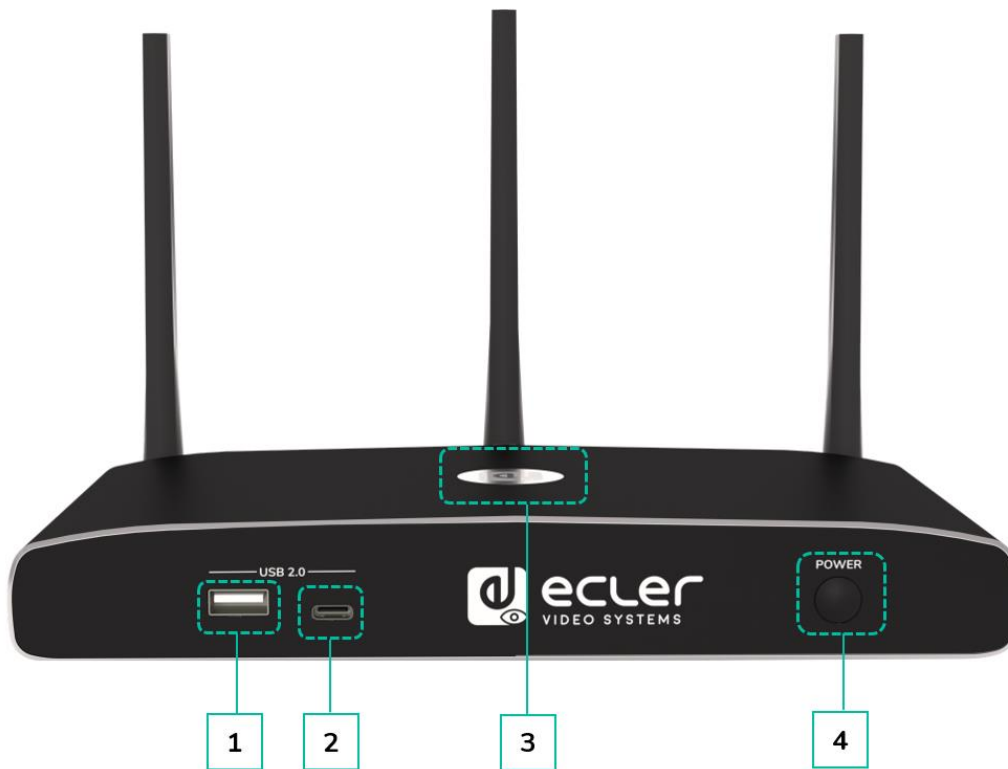

1. Front USB 2.0 Type A connector:

- To connect USB 2.0 devices
- To update the software of the VEO-SWC44.
- For pairing VEO-SWC44TH and VEO-SWC44, when the transmitter is plugged-in.

2. Front USB 3.0 Type C connector: VEO-SWC44TU pairing.

3. Back-lit LED indicator:

- **Red:** Initializing.
- **Flashing Green:** power on.
- **Static Green:** Ready to share.
- **Static Cyan:** Sharing.

4. Power Button: Turn on or off the device.

Home	Web 5	WebGUI Setting Management & Configuration	Network Settings	Display & Audio	Moderator Control	System Settings	Security Settings	Firmware Upgrade	Other Settings	UCC Device Manager	TECHNICAL DATA
HW	PRECAUTIONS	PACKAGE CONTENTS	DESCRIPTION & FEATURES	INSTALL & CONNECT	START-UP & OPERATION	FIRMWARE UPDATE	PANEL FUNCTIONS & WIRELESS TRANSMITTERS	TROUBLESHOOTING			

8.2 Rear Panel

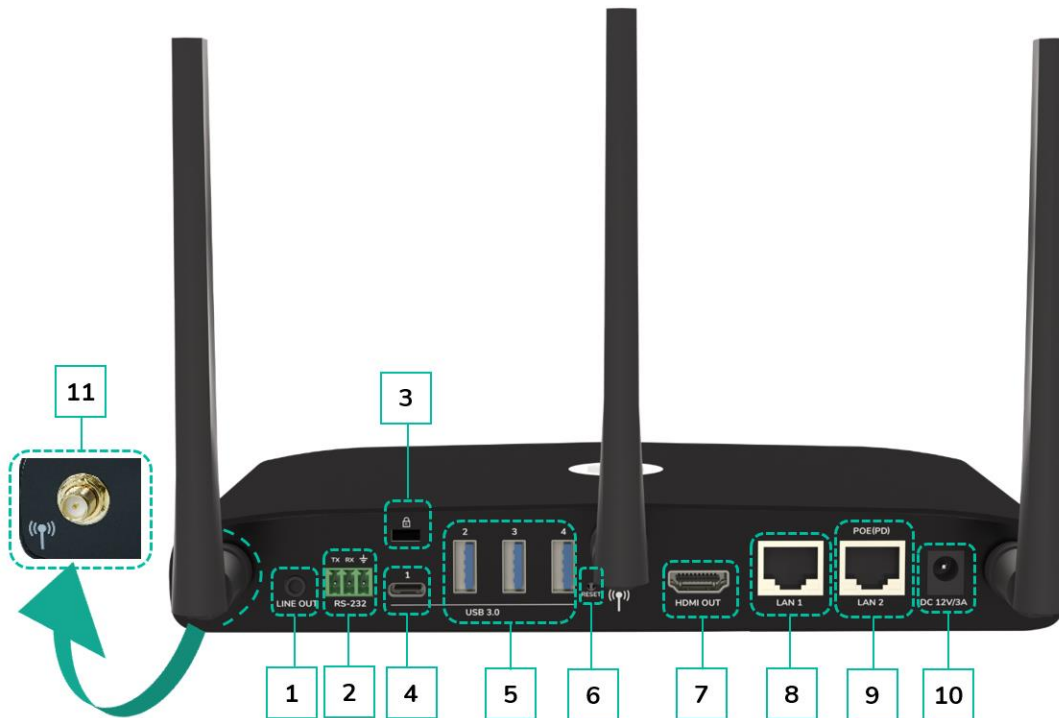

1. **Line audio output:** stereo analogue unbalanced audio output. Connect a 3.5mm mini-jack PC connector from this output to the Line in jack of an audio system.
2. **RS-232:** Connect an RS-232 cable from this port to an RS-232 device.
3. **Kensington Lock:** One end is wrapped around a fixed object and one end insert into this port to keep safety.
4. **Rear USB 3.0 Type-C connector:** To connect USB Type C devices.
5. **Rear USB 3.0 connector:** To connect USB 3.0 devices (touch screen, USB camera and mic or speaker).
6. **Reset:** Reset button to restore to the factory default setting. [For details, see chapter Factory Reset Using Rear Panel Button.](#)
7. **HDMI output:** Connect an HDMI cable from this port to an HD or 4K/HDMI2.0 display.
8. **LAN Ethernet port 1:** 100Mbps, connect an Ethernet cable between this jack and a LAN to connect the unit to LAN.
9. **LAN Ethernet port 2:** 1000Mbps, connect an Ethernet cable between this jack and a LAN to connect the unit to LAN. Support PoE.
10. **DC Power socket:** Connect the included power adapter to this socket and connect the plug to an available electrical outlet.
11. **Antenna fixing points:** Screw up the included three antennas to each of the three-attachment point. The antenna can rotate for a better covering.

Home	Web UI	Web UI Setting	Network Settings	Display & Audio	Moderator Control	System Settings	Security Settings	Firmware Upgrade	Other Settings	UCC Device Manager	TECHNICAL DATA
HW	Management & Configuration	DESCRIPTION & FEATURES	INSTALL & CONNECT	START-UP & OPERATION	FIRMWARE UPDATE	PANEL FUNCTIONS & WIRELESS TRANSMITTERS	TROUBLESHOOTING				
PRECAUTIONS	PACKAGE CONTENTS										

8.2.1 Factory Reset Using Rear Panel Button

By using this function, all previous settings will be lost, and you will need to do the set-up once more.

Start up the VEO-SWC44. When the Home Screen is displayed, press the reset button at the rear panel of VEO-SWC44. Press this button with a pointed object, e.g., an unbent paper clip for at least 2 seconds, until the “FactoryReset” page is displayed as below.

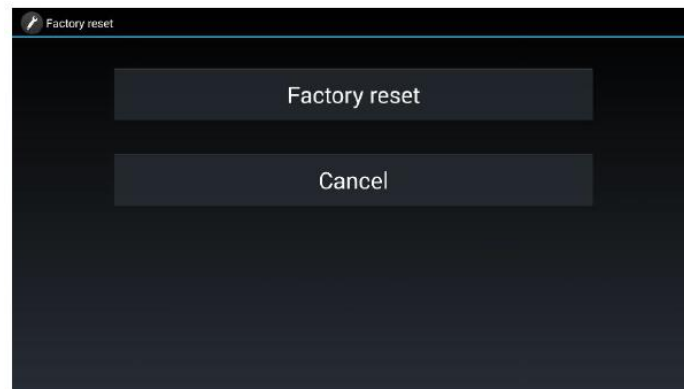

The VEO-SWC44 will reboot after 3 seconds to be default configuration.

 If VEO-SWC44 HDMI output is not connected to a display and no picture is available, press and hold the reset button until the red LED indicator on the top surface of VEO-SWC44 lights up to execute the reset process.

Factory Default Configuration is as following:

- **Ethernet:**
 - Proxy: None
 - DHCP: Enable
- **Wireless network:**
 - Frequency: 5GHZ
 - Channel: Auto
 - Auto change WiFi hotspot password: 5 minutes
- **Display & Audio**
 - HDMI resolution: Auto
 - HDMI CEC:
 - Device auto power off: ON
 - VEO-SWC44 auto power on: OFF
 - Audio output: Jack&HDMI
 - Airplay screen quality: High
 - Display device name and password when mirroring: OFF
 - Display PCs username when mirroring: ON

- **Moderator Control**
 - Add a sub-window bar to enable previewing the connected devices: ON.
 - Real time preview: ON.
- **System settings**
 - Date & time: Automatic date & time: use network-provided time.
 - Auto Standby: Never.
 - Language: English.
- **Security Settings**
 - Security Level: Security level 1.
 - Connection Password: 4-digits password beginning with 0000.
 - Change admin password: admin(default).
- **Other settings**
 - Auto create launcher: Disabled.
 - Clear history after meeting: Always.

Home	
HW	Web 5
PRECAUTIONS	WebGUI Setting Management & Configuration
PACKAGE CONTENTS	Network Settings
DESCRIPTION & FEATURES	Display & Audio
INSTALL & CONNECT	Moderator Control
START-UP & OPERATION	System Settings
FIRMWARE UPDATE	Security Settings
PANEL FUNCTIONS & WIRELESS TRANSMITTERS	Firmware Upgrade
TROUBLESHOOTING	Other Settings
TECHNICAL DATA	UCC Device Manager

8.3 Wireless Transmitters

8.3.1 VEO-SWC44TH

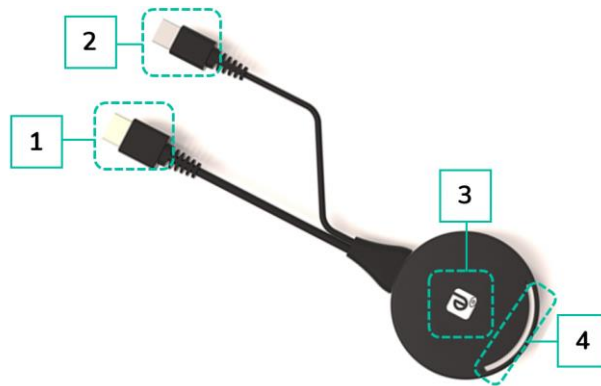

1. **HDMI connector:** Using HDMI connector of the button can be plugged into a PC/Laptop for sharing your screen.
2. **USB connector:** Supply power or plug into the VEO-SWC44 for pairing the Button to the VEO-SWC44 or upgrade the wireless transmitter.
3. **Touching Button:** Touch the sensor button to start displaying the content of the PC/Laptop's screen on the main screen. Touch the button during the meeting will toggle the sharing of the screen.
4. **LED ring indicator:** Indicates the status of the button. [For further information, see Led Indicator chapter.](#)

8.3.2 VEO-SWC44TU

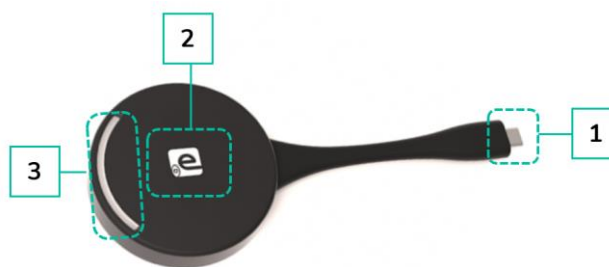

1. **Type C (DP)connector:** Using Type C (DP) connector of the button can be plugged into a PC/Laptop for sharing your screen.
2. **Touching Button:** Touch the sensor button to start displaying the content of the PC/Laptop's screen on the main screen. Touch the button during the meeting will toggle the sharing of the screen.
3. **LED ring indicator:** Indicates the status of the button. [For further information, see Led Indicator chapter.](#)

VEO-SWC44TU is full function type-C interface with DP Alt mod compliance, which supports audio and video transmission.

Home	Web 5	WebGUI Setting	Network Settings	Display & Audio	Moderator Control	System Settings	Security Settings	Firmware Upgrade	Other Settings	UCC Device Manager	TECHNICAL DATA
HW	Management & Configuration	PRECAUTIONS	PACKAGE CONTENTS	DESCRIPTION & FEATURES	INSTALL & CONNECT	START-UP & OPERATION	FIRMWARE UPDATE	PANEL FUNCTIONS & WIRELESS TRANSMITTERS	TROUBLESHOOTING		

8.3.3 LED Indicator

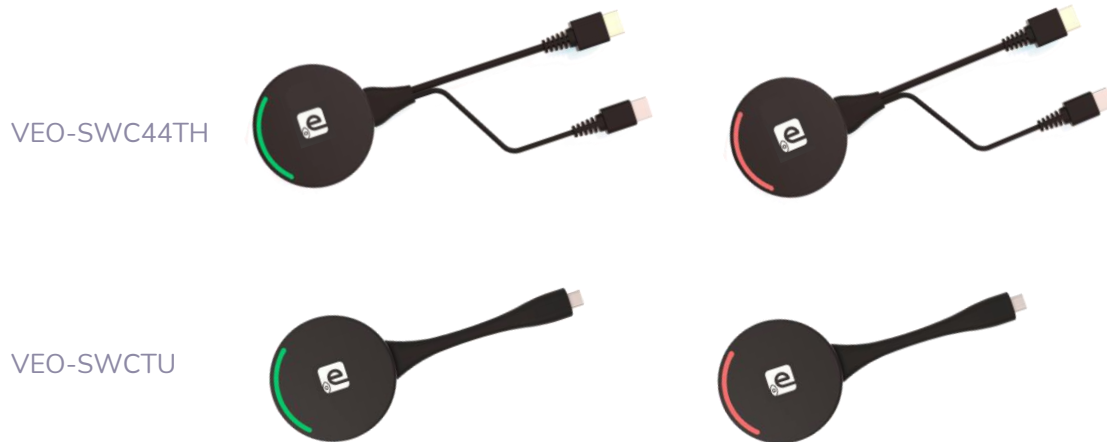

- VEO-SWC44TH / VEO-SWC44TU **connected to VEO-SWC44:**

First of all, a VEO-SWC44TH / VEO-SWC44TU needs to be connected to the VEO-SWC44 base unit:

- When LED indicator is **blinking Green**: the VEO-SWC44TH / VEO-SWC44TU is pairing with VEO-SWC44 base unit or firmware upgrading.
- When LED indicator is **static red**: pairing is done. VEO-SWC44TH / VEO-SWC44TU can be unplugged and ready to use.

- VEO-SWC44TH / VEO-SWC44TU **connected to a source device:**

First of all, a VEO-SWC44TH / VEO-SWC44TU needs to be connected to the source device. For example, to a PC:

- When LED indicator **is blinking Green**: the VEO-SWC44TH / VEO-SWC44TU is plugged in the laptop and initializing.
- When LED indicator is **static green**: it is ready to mirror the PC desktop on the main screen connected to VEO-SWC44 HDMI output.
- When LED indicator is **static red**: it is mirroring the PC desktop on the screen.

9. TROUBLESHOOTING

Here you can find **some fundamental problems and possible causes**, which can be happen **during the use of VEO-SWC44**. Find out the problem in the table below and **apply the indicated solution**.

Problem	Cause	Solution
Using VEO-SWC44 for Android application in Android device or Airplay on iOS device, it can't find VEO-SWC44 device.	WiFi password of VEO-SWC44 changed when android or iOS device is connected to the WiFi of VEO-SWC44.	Reconnect the mobile by entering password displayed on Home Screen.
Image quality on the main display screen is not good.	The quality or length of the cable between the VEO-SWC44 and the display or the connection between these two.	<ul style="list-style-type: none"> • Replace the cable • Use another cable. • Check the cable to be fasten properly.
	Improper resolution for the main screen.	Change the resolution on the Setting configuration and match it to the native resolution of the main screen. See chapter Resolution, section Display & Audio.
Bad wireless connection. The connection between the transmitter and the VEO-SWC44 is not stable.	WiFi problems. <ul style="list-style-type: none"> • Interference in the radio channel. • Overload in the radio channel. • VEO-SWC44 does not automatically jump to other channels when there are changes in the RF environment. 	<ul style="list-style-type: none"> • Use a WiFi scanner to find a free wireless frequency and channel and select it via the setting configuration. • Regularly check the RF environment if there are frequently changes in WiFi networks in your environment.
	Low signal strength: <ul style="list-style-type: none"> • Metal cabinets, walls, construction elements, can cause reflections deteriorating the wireless signal. • Obstacles between wireless transmitters and VEO-SWC44 cause lowering of the wireless strength and quality. 	<ul style="list-style-type: none"> • Put the VEO-SWC44 closer to the main screen. • Change the orientation of the antennas at the rear panel of VEO-SWC44 to the transmitter direction. • Remove or limit as much as possible all obstructions between the transmitters and VEO-SWC44. • Avoid placing the Base-unit in (metal) cabinets, suspended ceilings, under tables or in adjoining rooms.

Home	Web UI
PRECAUTIONS	WebGUI Setting Management & Configuration
PACKAGE CONTENTS	Network Settings
DESCRIPTION & FEATURES	Display & Audio
INSTALL & CONNECT	Moderator Control
START-UP & OPERATION	System Settings
FIRMWARE UPDATE	Security Settings
PANEL FUNCTIONS & WIRELESS TRANSMITTERS	Firmware Upgrade
TROUBLESHOOTING	Other Settings
TECHNICAL DATA	UCC Device Manager

Cannot get the VEOShare run when plug the transmitter to Laptop.	When you are using VEO-SWC44” for the first time on your laptop or for guests, you must copy the Launcher program VEOShare for first on your Laptop / PC. Run this Starter-program. You can run the Starter App without Admin-rights.	There are 2 possibilities to load the Launcher program, see chapter System Settings . The best is: to download the App via LAN or WiFi of Base-unit. When the Launcher program is preinstalled one time, VEOShare is ready to use later immediately.
	Bad connection at USB port on the Laptop.	<ul style="list-style-type: none"> • Reconnect to the USB port. • Try another USB port. • Reboot the Laptop.
	Some types of USB devices might be blocked as the company policy. USB port setting on the Laptop might limit the usage of high power USB device when on battery power.	If possible, change the USB port policy on the Laptop.
Low video performance (sharpness, audio and video dropouts, video stream is jerking, ...)	<ul style="list-style-type: none"> • The media-player is not ideal. • The video quality also depends on the computing power of the PC / laptop and the interaction and CPU load with other running software applications. • A laptop in battery mode can be switched to reduced computer power, to save energy. The transmission of HD video requires a certain amount of CPU power to guarantee the optimum quality of the transmission. 	<ul style="list-style-type: none"> • Use another media-player (VLC player...), another browser. • Update the software of your Video-player to the latest version. • Reduce the CPU usage of other software applications. • Lower the screen resolution of the laptop. • Update driver of graphic card. • End low power mode at laptop.
Video is not shown on screen	The content use HDCP	VEO-SWC44 input cannot support showing HDCP source. If possible, connect the source device to local HDMI input at VEO-SWC44.
	The display cable (HDMI) is not correctly connected.	Insert the display cable to the display and the Base-unit.
	The displays are switched off.	Switch on the display.
	The VEO-SWC44 base-unit is in standby mode, “Power-LED” is flashing at VEO-SWC44 Power-supply is missed.	Power off and on again or insert a wireless transmitter into laptop.

	Web 5
HW	Web 5
PRECAUTIONS	WebGUI Setting Management & Configuration
PACKAGE CONTENTS	Network Settings
DESCRIPTION & FEATURES	Display & Audio
INSTALL & CONNECT	Moderator Control
START-UP & OPERATION	System Settings
FIRMWARE UPDATE	Security Settings
PANEL FUNCTIONS & WIRELESS TRANSMITTERS	Firmware Upgrade
TROUBLESHOOTING	Other Settings
TECHNICAL DATA	UCC Device Manager

When using Windows 7, the following message about the Window Aero colour scheme appears “Windows has detected your computer’s performance is slow. This could be because these are not enough resources to run the windows Aero colour scheme. To improve...”	VEO-SWC44 uses resource from the GPU. In combination with other programs which do so, Windows 7 sometimes displays this message suggesting disabling Aero to improve the performance of Laptop.	It is safe to ignore this message and choose “Keep the current colour scheme.”
Your content is removed from the display and the LEDs on the button are blinking.	Connection to the VEO-SWC44 is lost.	VEO-SWC44 tries to restore the connection automatically. If it fails, the LEDs on the button start blinking red. Unplug the button from your Laptop and try a new button.
Nothing is shown on the displays at all	The displays are switched off.	Switch on the display
	The display cable is not correctly connected.	Insert the display cable to the display and the VEO-SWC44.
	The VEO-SWC44 is in standby mode.	Briefly push the standby button on the VEO-SWC44 or power off and on again the VEO-SWC44.
No LAN connection with the VEO-SWC44.	Wrong IP address.	<ul style="list-style-type: none"> • IP address is not within LAN range. • DHCP is not enabled.
No WiFi connection between mobile device with VEO-SWC44.	Wrong WiFi frequency.	Check mobile device to select the correct 2.4GHz or 5GHz
	Wrong SSID and password	Enter the correct SSID.

Home	Web UI Management & Configuration	Network Settings	Display & Audio	Moderator Control	System Settings	Security Settings	Firmware Upgrade	Other Settings	UCC Device Manager	TECHNICAL DATA
HW	PRECAUTIONS	PACKAGE CONTENTS	DESCRIPTION & FEATURES	INSTALL & CONNECT	START-UP & OPERATION	FIRMWARE UPDATE	PANEL FUNCTIONS & WIRELESS TRANSMITTERS	TROUBLESHOOTING		

No audio when transmit local file to VEO-SWC44.	Unsupportive audio format, including Dolby MS11, DDCO DTSLBR, DTSE, SRS-THEATERSOUND, DTS_StudioSound3D, DTS_HD.	If possible, reformat it to the other audio format, like DD, DD+, HE-AAC, DTS DMP, WMA, DRA, COOK
There is no sound at main display.	No connected audio device.	Make sure, the audio is turned on.
	Volume is set to OFF.	Adjust the volume level at Options in menu of VEO-SWC44.
	The volume level is set too low in the options of the VEOShare app program on PC.	Adjust the volume in the VEOShare app on PC.
	Audio signal may be muted.	Click with right-mouse button at speaker icon in taskbar and switch on.
	The volume level is set too low.	Adjust the volume level at Options in menu of VEO-SWC44.
	Audio is muted in mixer of volume in taskbar.	Right-mouse click at speaker icon in taskbar, open mixer and unmute VEO-SWC44 or “Video Playback”.
	The software of used Video-player is not actual.	Update Video-player. Try another player.
	An active virus scanner can block the Audio.	Check the filter-settings in Virus scanner. De-activate the player for a check.
There is no sound with MacBook.	Problem of sound-flower App, which is integrated in driver VEOShare app.	<ul style="list-style-type: none"> • You need Admin-password. • Go to the macOS System Preferences and select the “Security & Privacy” tab. Find the "allow to run/install the sound-flower" there click on “Allow” next to “Matt Ingalls”, to allow this sound-flower to install on the Mac Book. • Run the VEOShare app again, it'll auto-install the sound-flower to the MacBook.

Home	
HW	Web UI
PRECAUTIONS	WebGUI Setting Management & Configuration
PACKAGE CONTENTS	Network Settings
DESCRIPTION & FEATURES	Display & Audio
INSTALL & CONNECT	Moderator Control
START-UP & OPERATION	System Settings
FIRMWARE UPDATE	Security Settings
PANEL FUNCTIONS & WIRELESS TRANSMITTERS	Firmware Upgrade
TROUBLESHOOTING	Other Settings
TECHNICAL DATA	UCC Device Manager

There is no sound via AirPlay.	The volume is set too low, on the mobile device.	Increase the volume on the mobile device.
There is no sound at main-screen, when mirroring a video by the App “VEOShare for Android”.	Due to the limit of the Android system, Android doesn’t provide an interface to capture the audio. In this case, there is no sound when mirroring the video.	Use wireless transmitter or Apple Airplay to do mirroring when necessary.
Cannot update firmware of the VEO-SWC44.	Flash disk format is NTFS.	Please re-format the flash disk to be FAT format to update it.
Cannot work airplay with MacBook / iPhone / iPad.	Operation System Requirement Mac OS 10.9 iOS 8.0 and later (VEOShare app).	<ul style="list-style-type: none"> • To use AirPlay, you must connect the iOS device to the WiFi of VEO-SWC44 and enable the AirPlay feature in the Control Center. • Update the iOS device to a newer operating system.
Poor Video-quality with AirPlay.	There are 2 states for AirPlay: a.) Mirroring: 1: 1 copy of the screen b.) Streaming: Videos (Internet, Youtube); the image will not be displayed on the iOS device. => picture is jerky.	Reduce “Quality” in settings of Youtube, for example from “Automatic” to 720p.
Cannot work with Android device.	Operation System Requirement Android 2.3 and later (VEOShare app).	Update to the later OS.

Home	
HW	Web UI
PRECAUTIONS	WebGUI Setting Management & Configuration
PACKAGE CONTENTS	Network Settings
DESCRIPTION & FEATURES	Display & Audio
INSTALL & CONNECT	Moderator Control
START-UP & OPERATION	System Settings
FIRMWARE UPDATE	Security Settings
PANEL FUNCTIONS & WIRELESS TRANSMITTERS	Firmware Upgrade
TROUBLESHOOTING	Other Settings
TECHNICAL DATA	UCC Device Manager

10. TECHNICAL DATA

10.1 Technical Specifications

VEO-SWC44

Video Performances	
Video Input Connectors	USB 3.0, USB-C, USB 2.0 (UVC)
Video Output connectors	HDMI Type A Female, 1.4, 10.2 Gbps
Video Input Resolution	1080p@60Hz
Video Output Resolution	3840x2160@60Hz, 3840x2160@50Hz, 3840x2160@30Hz, 1920x1080@60Hz, 1920x1080@50Hz, 1920x1080@30Hz, 1280x720@60Hz, 1280x720@50Hz
HDCP	2.2
Video Composing Capabilities	Multiviewing up to 4 windows; 16 participants on hold
Screen Mirroring	Airplay, Chromecast, Miracast, VEOShare app, Wireless Transmitter
Wireless Conferencing	Yes
Other Features	Whiteboard annotation tool, Wireless Touchback, Customizable background
HDMI Distance	10m with Ecler VEO Cables
Audio Performances	
Audio Output Connectors	Jack 3.5mm
Audio Formats	PCM 2.0
Audio De-Embedding	Yes
Device Control	
Control Connectors	USB Type A, Euroblock, RJ-45
Control Protocols	Web, Telnet, RS-232
Control Buttons	1 x Power ON button
EDID Management	Software
Status Indicators	Input LED Multicolour
Network	
Network Connectors	2 x RJ-45 (LAN port 1 is 100Mbps and LAN port 2 is 1Gbps), WiFi (Wireless transmission protocol is WIFI IEEE 802.11 a/g/n/ac. Compatible with 2.4 GHz and 5GHz frequency bands)
Average Streaming Bitrate	Up to 1200Mbps
Transmission Distance	100m via Ethernet Network
Electrical	
Power Supply	PoE (IEEE802.3af.) or External Power supply
AC Mains Connector	100-240VAC 50-60Hz with EU, UK, US, AU blades
DC Mains Connector	12VDC-1A with coaxial DC connector
Power Consumption	10W
Physical	
Operating Temperature	Min: -20°C; -4°F / Max: 60°C; 140°F
Operating Humidity	<90% HR
Installation Options	Desktop
Included Accessories	1 x 3pin Euroblock connector, 3 x antennas, 1x12V PSU
Optional Accessories	VEO-SWC44TH, VEO-SWC44TU
Dimensions (WxHxD)	220 x 32x 120 mm. / 8.66 x 1.26 x 4.72 in. 220 x 145 x 120 mm. / 8.66 x 5.71 x 4.72 in.(including antenna)
Shipping Dimensions (WxHxD)	340 x 77 x 208 mm. / 13.38 x 3.03 x 8.19 in.
Weight	1 Kg / 2,2 lb

Home	Web UI Management & Configuration	Network Settings	Display & Audio	Moderator Control	System Settings	Security Settings	Firmware Upgrade	Other Settings	UCC Device Manager	TECHNICAL DATA
HW	PRECAUTIONS	PACKAGE CONTENTS	INSTALL & CONNECT	START-UP & OPERATION	FIRMWARE UPDATE	PANEL FUNCTIONS & WIRELESS TRANSMITTERS	TROUBLESHOOTING			

Shipping Weight	1.25 Kg / 2.76 lb
Chassis Material	Metal
Finished Colour	Black

VEO-SWC44TH (optional accessory)

Video Performances	
Video Input Connectors	HDMI Type A Female, 1.4, 10.2 Gbps
Video Input Resolution	1080p@60Hz
Video Output Resolution	1080p@60Hz
HDCP	2.2
Device Control	
Status Indicators	Input LED Multicolour
Electrical	
Power Supply	USB power 5V
DC Mains Connector	USB Type A
Power Consumption	maximum 3W
Physical	
Operating Temperature	Min: -20°C; -4°F Max: 60°C; 140°F
Operating Humidity	<90% HR
Dimensions (WxHxD)	70 Ø x 15 mm x 225 mm. / 2.76 Ø x 0.59 in. x 8.86 in.
Weight	0,09 Kg / 0.20 lb
Shipping Dimensions (WxHxD)	232 x 34 x 95 mm. / 9.13 x 1.33 x 3.74 in.
Shipping Weight	0.15 Kg / 0.33 lb
Chassis Material	Metal
Finished Colour	Black

VEO-SWC44TU (optional accessory)

Video Performances	
Video Input Connectors	USB Type C, 3.1, 5Gbps
Video Input Resolution	1080p@60Hz
Video Output Resolution	1080p@60Hz
HDCP	2.2
Device Control	
Status Indicators	Input LED Multicolour
Electrical	
Power Supply	USB power 5V
DC Mains Connector	USB Type C
Power Consumption	maximum 3W
Physical	
Operating Temperature	Min: -20°C; -4°F Max: 60°C; 140°F
Operating Humidity	<90% HR
Dimensions (WxHxD)	70 Ø x 15 mm x 225 mm. / 2.76 Ø x 0.59 in. x 8.86 in.
Shipping Dimensions (WxHxD)	232 x 34 x 95 mm. / 9.13 x 1.34 x 3.74 in.
Weight	0,09 Kg / 0.20 lb
Shipping Weight	0.15 Kg / 0.33 lb
Chassis Material	Metal
Finished Colour	Black

Home	Web UI
PRECAUTIONS	WebUI Setting Management & Configuration
PACKAGE CONTENTS	Network Settings
DESCRIPTION & FEATURES	Display & Audio
INSTALL & CONNECT	Moderator Control
START-UP & OPERATION	System Settings
FIRMWARE UPDATE	Security Settings
PANEL FUNCTIONS & WIRELESS TRANSMITTERS	Firmware Upgrade
TROUBLESHOOTING	Other Settings
TECHNICAL DATA	UCC Device Manager

10.2 Mechanical Diagram

VEO-SWC44

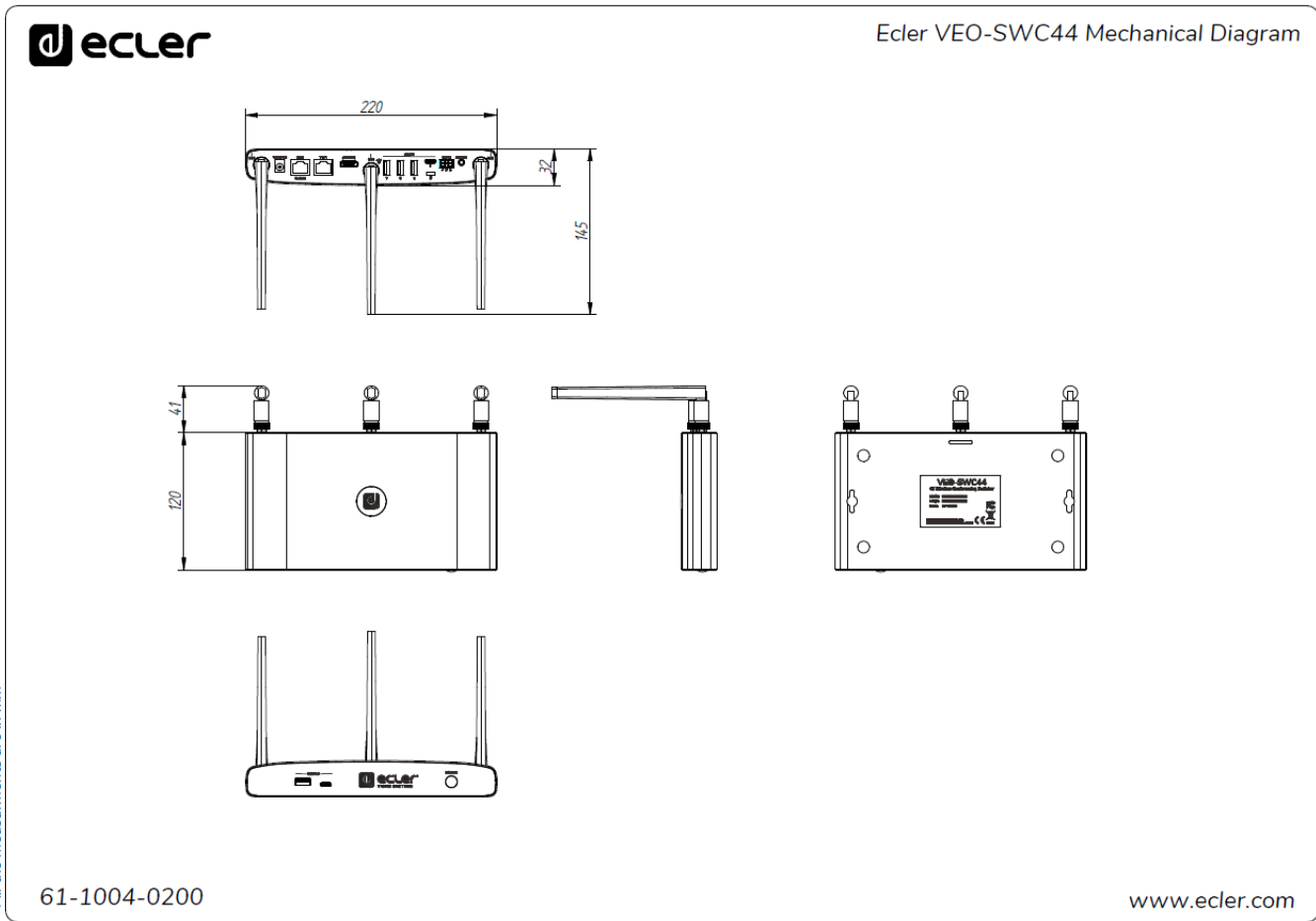

Home	Web GUI	WebGUI Setting	Network Settings	Display & Audio	Moderator Control	System Settings	Security Settings	Firmware Upgrade	Other Settings	UCC Device Manager	TECHNICAL DATA
HW	Management & Configuration	PRECAUTIONS	PACKAGE CONTENTS	DESCRIPTION & FEATURES	INSTALL & CONNECT	START-UP & OPERATION	FIRMWARE UPDATE	PANEL FUNCTIONS & WIRELESS TRANSMITTERS	TROUBLESHOOTING		

VEO-SWC44TH



Ecler VEO-SWC44TH Mechanical Diagram

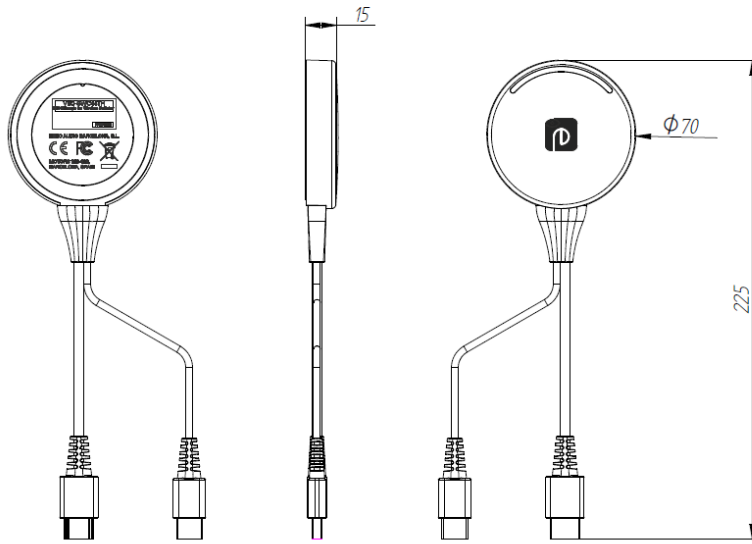

All the measurements are in mm

61-1007-0400

www.ecler.com

VEO-SWC44TU



Ecler VEO-SWC44TU Mechanical Diagram

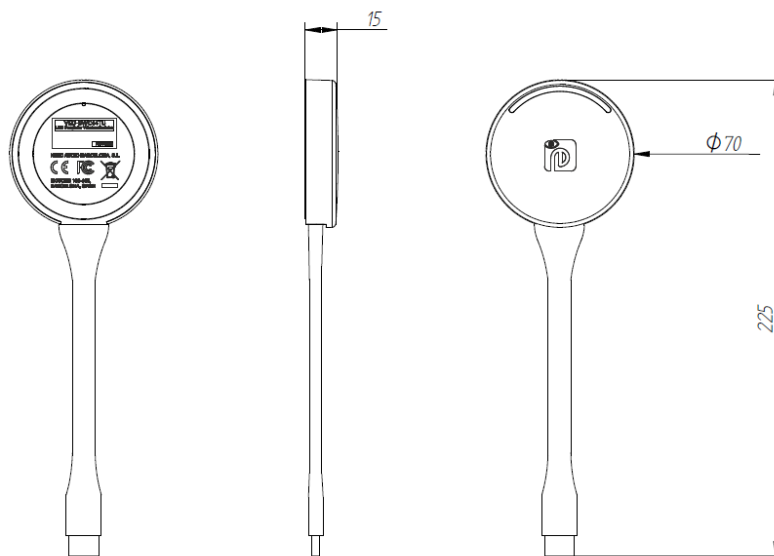

All the measurements are in mm

61-1006-0400

www.ecler.com

Home	Web GUI	WebGUI Setting	Network Settings	Display & Audio	Moderator Control	System Settings	Security Settings	Firmware Upgrade	Other Settings	UCC Device Manager	TECHNICAL DATA
HW	Management & Configuration	PRECAUTIONS	PACKAGE CONTENTS	DESCRIPTION & FEATURES	INSTALL & CONNECT	START-UP & OPERATION	FIRMWARE UPDATE	PANEL FUNCTIONS & WIRELESS TRANSMITTERS	TROUBLESHOOTING		

Home	WebGUI Management & Configuration	Network Settings	Display & Audio	Moderator Control	System Settings	Security Settings	Firmware Upgrade	Other Settings	UCC Device Manager	TECHNICAL DATA
HW	PRECAUTIONS	PACKAGE CONTENTS	DESCRIPTION & FEATURES	INSTALL & CONNECT	START-UP & OPERATION	FIRMWARE UPDATE	PANEL FUNCTIONS & WIRELESS TRANSMITTERS	TROUBLESHOOTING		



All product characteristics are subject to variation due to production tolerances. **NEEC AUDIO BARCELONA S.L.** reserves the right to make changes or improvements in the design or manufacturing that may affect these product specifications.

For technical queries contact your supplier, distributor or complete the contact form on our website, in [Support / Technical requests](#).

Motors, 166-168 -08038 Barcelona - Spain-(+34) 932238403 | information@ecler.com | www.ecler.com